



HEUFT PRODUCTS
for the beverage industry



PERFECT QUALITY

FROM THE BEGINNING TO THE END

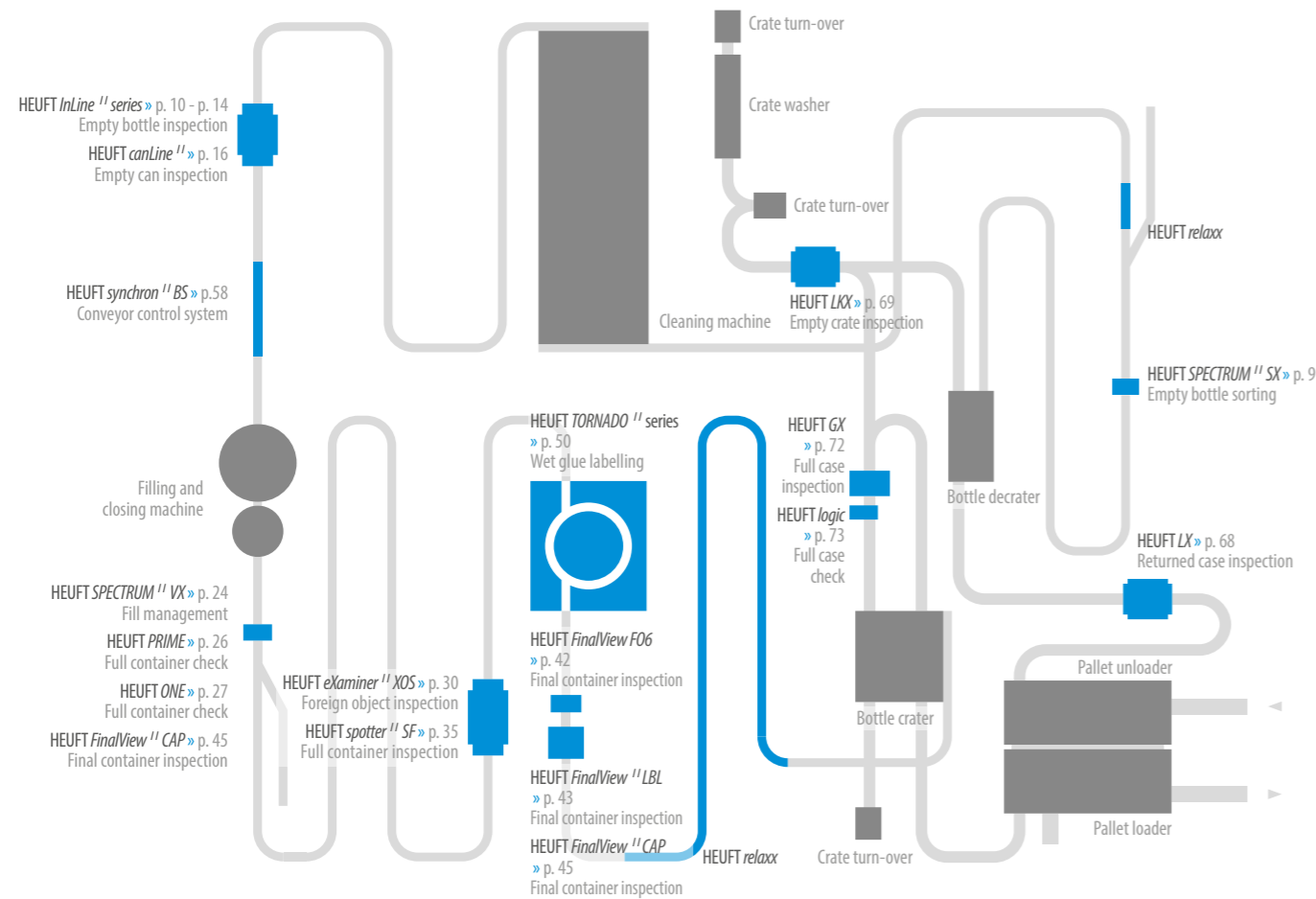

EMPTY BOTTLE SORTING

HEUFT SPECTRUM *'' SX* p. 9

EMPTY CONTAINER INSPECTION

HEUFT InLine *'' IXS* p. 12
 HEUFT InLine *'' IS* p. 13
 HEUFT InLine *'' IR* p. 14
 HEUFT canLine *''* p. 16

FULL CONTAINER CHECK & FILL MANAGEMENT

HEUFT SPECTRUM *'' VX* p. 24
 HEUFT PRIME p. 26
 HEUFT ONE p. 27

FOREIGN OBJECT AND PRODUCT INSPECTION

HEUFT eXaminer *'' XOS* p. 30
 HEUFT eXaminer *'' XAC* p. 31
 HEUFT eXaminer *'' XS* p. 34
 HEUFT floater p. 37
 HEUFT spotter *'' SF* p. 38

LEAKAGE CHECK

HEUFT squeezer *'' QS* p. 41
 HEUFT exciter p. 42

FINAL CONTAINER INSPECTION

HEUFT FinalView FO6 p. 45
 HEUFT FinalView *'' LBL* p. 46
 HEUFT FinalView *'' CAP* p. 48

LABELLING

HEUFT TORNADO *'' dynamic* p. 53
 HEUFT TORNADO *'' classic* p. 54
 HEUFT TORNADO labelling units p. 56

CONTAINER TRANSPORT

HEUFT conveyor & HEUFT synchron *'' BS* p. 61
 HEUFT synchron TXI p. 62
 HEUFT LAMBDA-K p. 64

FAULT REJECTION

HEUFT pusher, HEUFT mono, HEUFT e-mono, p. 65
 HEUFT flip, HEUFT DELTA-FW, HEUFT DELTA-K p. 66

EMPTY CASE INSPECTION

HEUFT LX p. 71
 HEUFT LXX p. 72

FULL CASE INSPECTION

HEUFT GX p. 75
 HEUFT logic p. 76

CASE REJECTION (HEUFT case rejector)

HEUFT xcase, HEUFT xtray, p. 77
 HEUFT maxi-flip, HEUFT maxi-laner p. 78

PDA & LINE ANALYSIS

HEUFT PROFILER family p. 81
 HEUFT RECIPER p. 83
 HEUFT picCollect p. 84

COMPANY

Life Cycle Partnership p. 85

24/7 SERVICE

GLOBAL PLAYER / GLOBAL SERVICE p. 87
 HEUFT TeleService p. 89
 HEUFT PhoneService p. 90
 HEUFT DirectService p. 90
 HEUFT DeviceSupport p. 90

COMPANY

SHOWROOM p. 91
 TRAINING p. 91
 SERVICE p. 92
 CONFERENCES p. 92

TECHNOLOGICAL MILESTONES

1978 to 2019 p. 93



YOUR PRODUCT.
TRUE INSPECTION.
SAFEGUARDING
PERFECT QUALITY.

Quality, safety and efficiency: this is what matters when filling and packaging food, drinks and pharmaceuticals! The modular solutions from HEUFT SYSTEMTECHNIK GMBH put these key factors into practice simply and effectively. They ensure, during maximum productivity, that only perfect products reach the market.



HEUFT SPECTRUM¹¹ SX

Returnable empty bottle sorting with the HEUFT *preWash¹¹* module for full brand purity and efficiency.

HOMOGENEOUS & ERROR-FREE

Sorting, checking and inspecting – safeguarding the quality of beverage containers before the filling process.

More efficiency and productivity

Precise sorting out of non-brand bottles, reliable prevention of faulty filling, standstills and production downtimes.

High detection reliability

Reliable detection of incorrect bottle formats and colours, reliable identification of sealed and non-sealable returnable empties, clear differentiation between glass and PET.

Easily cleanable empties

Effective protection against problems and stoppages of the washing machine thanks to the HEUFT *preWash¹¹* module for the timely detection and sorting out of empty bottles which cannot be safely cleaned for example due to residual lye or a high degree of contamination.

Minimum false rejection rate

Accurate rejection due to the combined evaluation of all the measuring results using fuzzy logic.

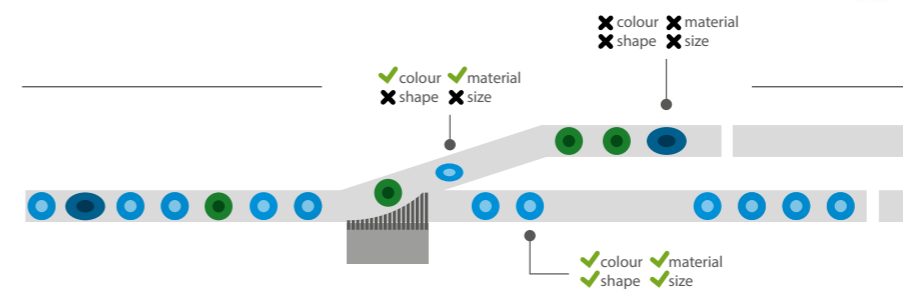

72^{up to},000
containers per hour



Discover more

Our devices for an empty container inspection.

From empty can to X-ray empty bottle inspection.

Out with faulty empties. In with safety and quality.

Perfect empty containers are essential in order to keep the quality and product safety of drinks at the highest level. Compact HEUFT *InLine* systems make sure that only perfect containers arrive at the filler. The continuous complete inspection of the full volume of each individual empty bottle using different detection technologies uncovers safety and quality defects reliably. The respective bottles are rejected consistently.

Effective protection against product recalls and liability cases

Reliable detection and targeted rejection of faulty empty bottles.

Superior technologies

Special sensory, optical and radiometric procedures for the reliable detection of a variety of faults.

No blind spots

Continuous base, sidewall, finish and thread inspection.

Maximum detection reliability with a minimum false rejection rate

Precise identification of residual liquid, foreign objects, contamination, inclusions, scuffing, cracks and defects. Clear differentiation between critical faults and harmless deviations for maximum line efficiency.



SIMPLY FINDING RELIABLY:
finish faults, chips, shell-shaped fractures and many other safety and quality defects.



HEUFT InLine^{II} IXS

X-ray assisted premium empty bottle inspection for an unprecedented detection reliability.

From the finish to the base

Optical complete inspection with a precise fine bottle alignment for coverage of up to considerably more than 360°. Double resolution during the sidewall inspection. Integrated residual liquid detections.

Unprecedented detection reliability

The highest ever detection performance at the lowest false rejection rate confirmed by independent experts. Precise identification of minute glass splinters in residual liquid due to unique pulsed X-ray technology.

Simply resource saving

Maximally automated HEUFT SPECTRUM^{II} system with self-explanatory HEUFT NaVi user guidance and fully automatic brand changes.

Analysis capable of learning

The HEUFT reflex^{A.I.} real-time high-performance image processing system with teach-in function.

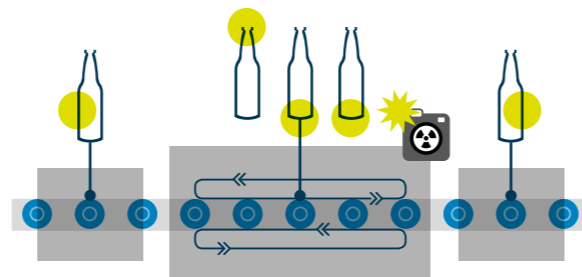

HEUFT InLine^{II} IS

The new standard for a superior empty bottle inspection on a HEUFT level.

Premium becomes standard!

Specific combination of trendsetting technologies from the premium empty bottle inspection of the new generation with a completely new, compact, hygiene-optimised and easy to maintain construction.

Comprehensive detection

Complete examination of all the areas of each bottle with real-time image analysis capable of learning for the identification of all risks and defects. Four-fold sidewall inspection for more than 360° coverage with double resolution.

Superior construction

Open, easily accessible HEUFT CleanDesign with neither frame nor machine table for minimum cleaning and uncomplicated maintenance. Even more compact than its predecessor despite the full integration of all the detection modules including residual lye detection.

Maximum automation and full operating reliability

Optimised bottle transport and fine alignment, automatic adjustment of all transport and detection units during brand changes. Highly automated HEUFT SPECTRUM^{II} platform with audiovisual HEUFT NaVi user guidance.

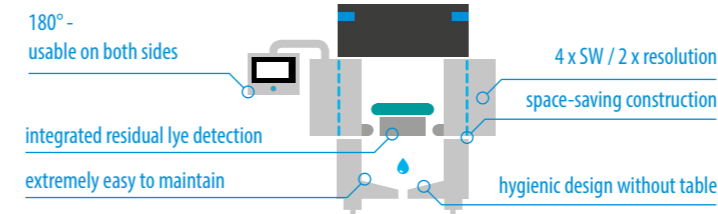

84 up to
containers per hour

1 2 3 4 5 6 7 8
EIGHT SIDE VIEWS
for coverage of up to 720°

Discover more



84 up to
containers per hour

Mehr entdecken



REAL-TIME IMAGE PROCESSING WITH ARTIFICIAL INTELLIGENCE!

In order to increase the detection accuracy of HEUFT systems and to reduce their false rejection rate we developed our own multi-processing hardware and software for real-time image processing decades ago which is optimally tailored to inline inspection applications.

Even in high-speed operation it realises a targeted object detection on the gapless detection images which are composed of several high-resolution images – and for more than ten years it has even realised a genuine object classification by means of *artificial intelligence (AI)*: From 2010 onwards, sufficient computing power was finally available to characterise recognised objects individually and to teach them into a multidimensional feature space.

Machine learning and experience for full detection reliability

Thanks to algorithms which automatically improve through experience and intelligent use of data this *machine learning* helps the HEUFT *reflexx AI* image processing to distinguish alleged faults even more clearly from actual ones. The proportion of perfect products and packages which are incorrectly rejected is reduced accordingly so that undesirable packaging and food waste is curbed in the long term.

And the performance of our completely self-developed real-time image processing reaches new dimensions with the HEUFT *reflexx AI* camera which evaluates high-resolution images directly when they are taken.

HEUFT InLine^{II} IR

Your affordable entry to a true empty bottle inspection on a HEUFT level.



The forerunner with new power

Proven construction and detection technologies of the long-standing benchmark regarding empty bottle inspection combined with the performance and self-explanatory user guidance of the new generation.

Ideal for newcomers

From a residual liquid detection, base, finish and thread inspection on less than one square metre of floor space to a complete inspection of all the areas of the bottle: flexible modules, equipment and configuration options for small and large demands, performance ranges and installation positions.

Simply more performance!

The HEUFT *SPECTRUM II* platform for a significant increase in computing and detection power, the HEUFT *reflexx AI* for a real-time image analysis and the HEUFT *NaVi* for ease of operation.

Perfect price / performance ratio

True empty bottle inspection on a HEUFT level at the best possible conditions.



Discover more

up to 72,000 containers per hour



space-saving

FLOOR SPACE LESS THAN 1m²



MODULAR

ENLIGHTENMENT



HEUFT *canLine* II

Further developed empty can inspection based on the HEUFT *SPECTRUM* II for simply more product safety and productivity.

Full productivity

Precise identification of shape deviations such as oval neck finishes and timely rejection of affected beverage cans for effective protection against blockages in the closure which slow down productivity.

Full packaging integrity

Reliable top-down detection of indentations in the crimp flange, dents, defects, contamination, rust, oil and grease residues on the inner rim and walls as well as contamination and foreign objects on the can base.

Full coverage empty can inspection

Only one, flexibly positionable top-down colour sensor camera with directly integrated LED illumination and image converter technology for comprehensive rim, inner wall and base inspection. Optional detailed supplementary inspection of the inner shoulder area directly below the can opening.

Full automation, full support

Modern HEUFT *SPECTRUM* II control unit with self-explanatory HEUFT *NaVi*-user guidance for fully automatic, audio-visually assisted sort and programme changes, among other things.



Discover more

144 up to
containers per hour

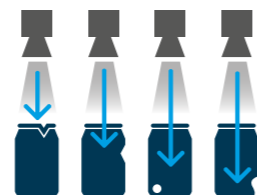

**ONE CAMERA
FULL INSPECTION**





Inspecting empty and full containers automatically

Rejecting faulty products automatically

Changing brands automatically and assisted

Detecting quality defects automatically



Universal device platform

CROSS-SYSTEM, HIGHLY AUTOMATED AND POWERFUL!

Its consistent modular design principle for a variety of technologies, modules, functions and applications makes HEUFT solutions stand out. A universal platform for individually equipped devices was created with the HEUFT SPECTRUM TX almost twenty years ago.

The HEUFT SPECTRUM II goes one step further!

The new generation control unit capable of multiprocessing is just as impressive as its predecessor with a cross-system component equality of 70%, a correspondingly high spare parts availability and a future-proof network connection. In addition it saves valuable human resources due to an exceptional degree of automation and a self-explanatory human machine interface with the audiovisual HEUFT NaVi user guidance.

The latest in-house developed hardware and software for significantly more computing power and for real-time data transmission quadruples the precision during purposeful product tracking:

the actual position of each individual container can be accurately determined up to 0.5 millimetres.

This ensures that each one is really inspected and each faulty one is removed reliably.

SAFEGUARDING PRODUCT QUALITY? SIMPLY AUTOMATICALLY! SIMPLY EASY!

HEUFT SPECTRUM II systems work fully automatically most of the time. The rest is covered by the HEUFT NaVi – with individual support and audiovisual step by step assistance. This

- saves time and resources
- increases the detection reliability
- safeguards error-free operation time

during the in-line quality inspection of empty and full containers. SIMPLY EASY!





CHECKED & PRECAUTIONS TAKEN

Checking, detecting and preventing – finding quality defects such as fill level and closure faults reliably and exposing the causes in good time.

Our devices for a full container check and inspection

From fill level check up to an extensive filler and closure management.

Up with product quality. Up with productivity.

Maximum product quality and maximum filler and closer efficiency: checking devices and fill management systems from HEUFT ensure both. Proven functions for checking and inspecting full containers safeguard product quality. Serial fault detection and continuous monitoring uncover losses in the performance of the filler / closer system before the efficiency and productivity of the complete filling line suffers.

Highest product quality

Reliable identification and sorting out of underfilled, overfilled, unsealed and unlabelled bottles.

Highest productivity

Direct localisation of sources of interference and error for early, preventive maintenance.

Highest production quality

Continuous product tracking, reliable quantifying and targeted sampling.

Highest availability

Reliable and easy to handle HEUFT systems.



FULL QUALITY AND FULL PRODUCTIVITY: finding fill level and closure faults reliably and locating their causes in good time.



HEUFT SPECTRUM " VX

Fill management based on the HEUFT SPECTRUM ".

Optimal product quality

Reliable detection of underfills and overfills, closure faults and burst bottles.

Preventive maintenance for maximum productivity

Early detection of losses in performance and sources of error due to consistent monitoring of the filler valves and closer heads.

Evaluation and distribution

Fill value statistics, sampling and container distribution onto up to seven lanes.

Superior operational reliability

Highly automated HEUFT SPECTRUM " system with self-explanatory HEUFT NaVi user guidance.

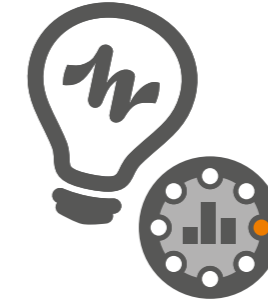

Locator, quantifying and fill management HIGH PRODUCT QUALITY AND HIGH OUTPUT!

It is good to find fill level and closure faults whilst still on the filling line. This offers protection against complaints and expensive product recalls. However it is even better to expose the causes of such quality defects at an early stage.

This prevents serial faults, line stoppages and costly productivity losses.

You can manage both with HEUFT! The devices for a full container check already have a locator function. It allocates detected faults to the corresponding filler valves and closer heads. A switch-off pulse is emitted when their number exceeds a certain, individually definable threshold value. Therefore interference can be eliminated in good time.

Fill management systems such as the HEUFT SPECTRUM " VX even go one step further – with an extensive filler and closer management. All the filler valves and closer heads are monitored continuously. Their respective performance is statistically evaluated.

Therefore the causes of deviations in filling quantities and closure faults are obvious long before they fail completely.

This gives you time for preventive maintenance before high false rejection rates and production downtimes can occur.



Discover more



ENLIGHTENMENT

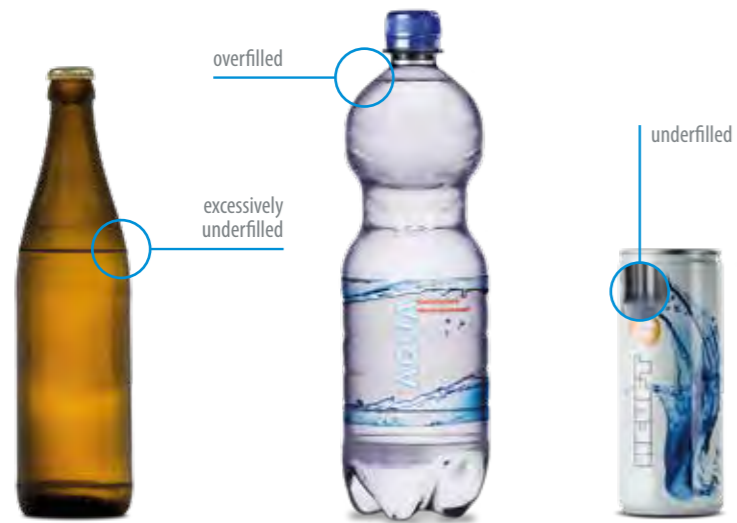

HEUFT PRIME

Full container check of the new generation.

High product quality

Reliable detection of incorrectly filled, not properly sealed, unlabelled and burst beverage containers and BBD check.

Increased line efficiency

Serial fault detection and early localisation of faulty filler valves.

No recalls

Reliable rejection of full containers with quality defects.

Easy operation

Automatic brand changes and extensive audiovisual step-by-step assistance.



HEUFT ONE

Your entry to a compact full container check on a HEUFT level.

ONE for all!

A completely new category of slimline devices for an affordable introduction to a reliable full container check.

Full quality check

Precise fill level detection for full containers. Smart sensor technology for examining the presence and position of the closure.

Space-saving construction and easy handling

Easy to integrate stand-alone system. Flexibly combinable detections directly on the conveyor connected to a compact control unit designed for optimum hygiene. Easy brand changes. Clear display with the HEUFT NaVi user interface for straightforward operation.

Real cutting-edge technology on a HEUFT level

Affordable complete solution comprising innovative detection technologies, in-house developed hardware and software and proven procedures for highly precise product tracking, inspection and fault rejection. Additional detection modules can be connected e.g. code verification.



72,000
up to
containers per hour

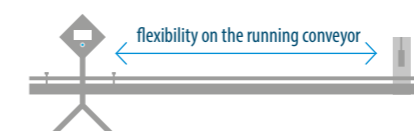
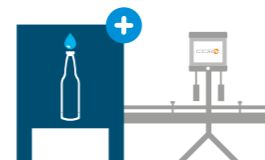

72,000
up to
containers per hour



Discover more

Our devices for a reliable foreign object and defect detection

From metal detection to glass in glass detection.



Contamination inside. Full container out.

Glass splinters, metal fragments, stones, paper or scraps of film: contamination with foreign objects is one of the most frequent causes of product recalls. It poses a serious health hazard to the consumer. You can eliminate this with HEUFT. Contaminated full containers are identified and rejected reliably whilst still on the line. Whether high or low density foreign objects or opaque or transparent: the most varied types of contamination are detected precisely using the right technology. Even faults barely noticeable with the naked eye cannot escape the inspection. This creates maximum product safety.

Safe products

Precise identification of foreign objects which are hazardous to health.

Protection against product recalls

Timely rejection of contaminated beverage packaging.

Full transparency

Different technologies for the reliable identification of a wide range of different foreign objects.

Smart demarcation

Reduction in the false rejection rate due to a clear distinction between real and supposed faults.



BROAD SPECTRUM:
identifying high and low density
foreign objects reliably.

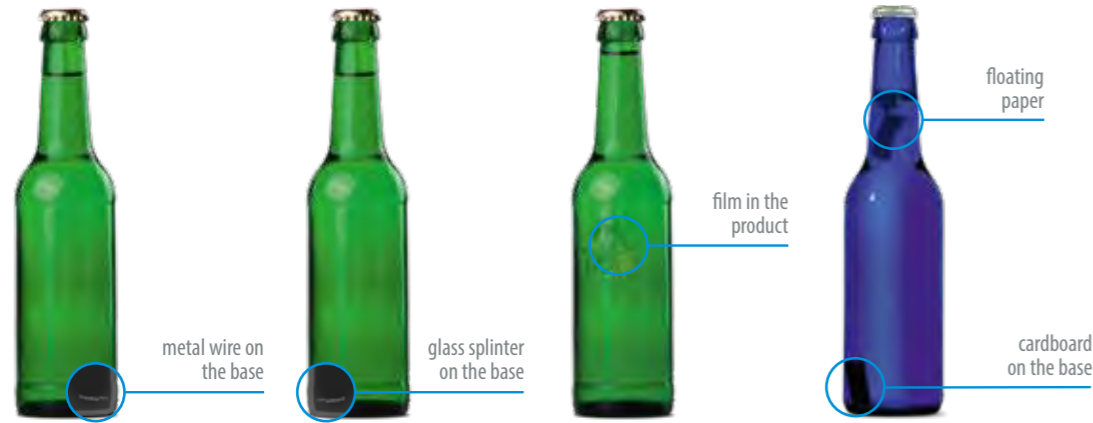

HEUFT eXaminer^{II} XOS

Foreign object inspection of the new generation with unique X-ray strobes.



Broad spectrum

From glass splinters, mould to transparent film: the reliable detection of high density and low density foreign objects in full containers.

Complete inspection without blind spots

Continuous inspection of the total container volume.

X-ray flash instead of a permanent beam

Sharp images with minimum radiation.

Less false rejections

Highly precise product tracking and the HEUFT *reflex*^{A.1} real-time image processing system with learning ability for clearly differentiating between real and supposed safety risks.

* In a case of defect within this period we guarantee a free replacement of the X-ray image converter within a framework of an existing After Sales contract.



72,000
up to
containers per hour

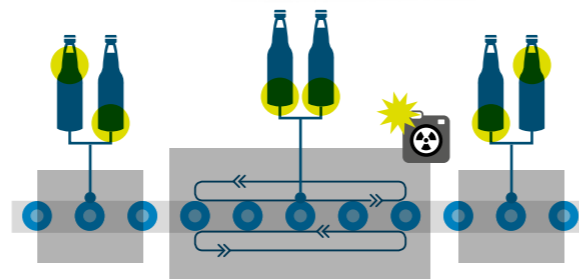

* One HEUFT X-ray flash

HEUFT eXaminer^{II} XAC

Foreign object inspection of the new generation with pulsed X-ray technology.



Prevention of product recalls and liability cases

Identification of dangerous foreign objects already during the filling process.

Maximum detection reliability

Sharp, high-resolution X-ray images with minimum radiation.

Continuous examination of large size containers

Full coverage due to particularly large sensitive detection surface.

Self-explanatory and simply easy

Error-free operation due to maximally automated HEUFT *SPECTRUM*^{II} platform and self-explanatory audiovisual user guidance.

* In a case of defect within this period we guarantee a free replacement of the X-ray image converter within a framework of an existing After Sales contract.

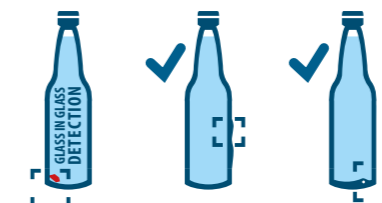
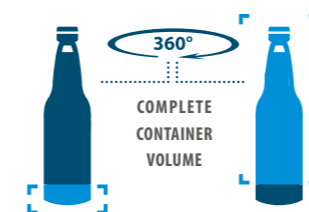

72,000
up to
containers per hour



Discover more

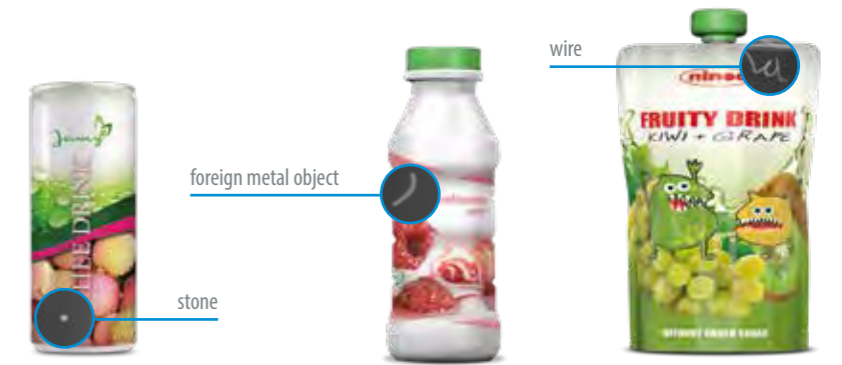

HEUFT *eXaminer* ^{II} XS

Space-saving lateral inspection with pulsed X-ray for foreign body detection at the end of the line.

Foreign object detection at HEUFT level

Gentle and precise detection of high-density foreign bodies in freshly filled beverage cans, squeeze bottles, stand-up pouches and doypacks.

Full coverage in the smallest space

Optimally positioned, securely housed X-ray strobes for full detection reliability without blind spots from the container base to the filling line area.

Fewer false rejections

Highly precise container tracking and intelligent HEUFT *reflexx* ^{A.I.} image processing for reliable differentiation between actual and apparent safety risks.

Full operational and manipulation safety

Highly automated HEUFT *SPECTRUM* ^{II} system with self-explanatory HEUFT *NaVi* user guidance for safe, error-free operation.



* In a case of defect within this period we guarantee a free replacement of the X-ray image converter within a framework of an existing After Sales contract.

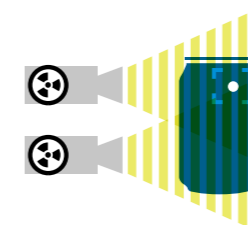
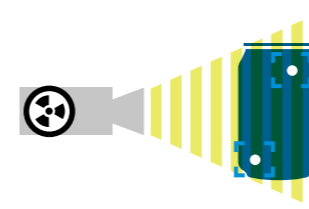

72 ^{up to}
containers per hour





Pulsed X-ray technology

MAXIMUM PRECISION AND MINIMUM RADIATION!

HEUFT X-ray systems identify foreign objects, product faults and packaging defects both precisely and carefully. In contrast to the conventional X-ray scanner their unique pulsed X-ray technology only emits radiation at the moment when a product to be examined is in the inspection area. And that as an X-ray flash lasting just a thousandth of a second.

The extremely short exposure time prevents motion blurs and reduces the average radiation exposure by a factor of 1,000.

No product is exposed to a higher dose than is absolutely necessary. Thus an X-ray strobe only emits radiation for 36 seconds when inspecting 36,000 containers per hour. As a result there is no emission whatsoever during 99% of the time. By contrast, conventional X-ray scanners emit radiation continuously for 60 minutes. That alone makes the pulsed X-ray technology unique.

Combined with innovative full-field image converters it achieves an unprecedented dimension in range, speed and detection accuracy.

The size of the foreign objects which can be reliably identified has been halved!

ENLIGHTENMENT



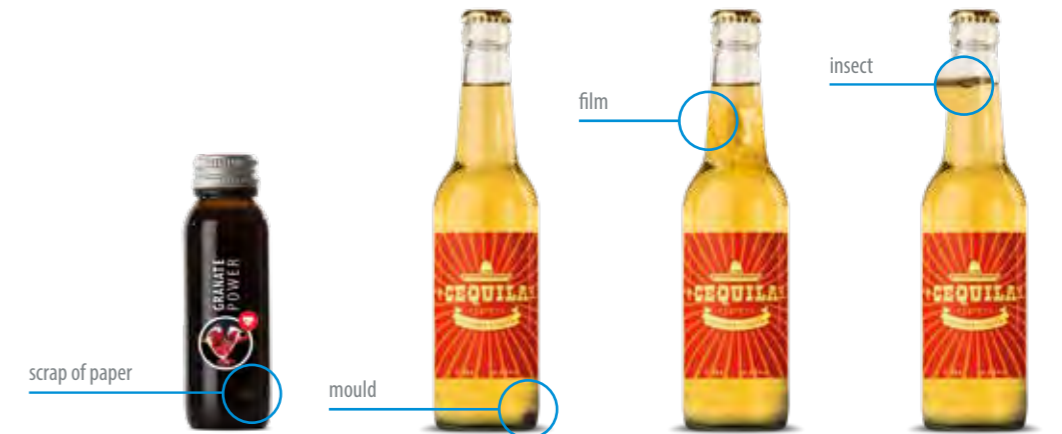

HEUFT floater

Foreign object inspection for the reliable detection of objects floating in the product.

Identification of inconspicuous safety risks

Reliable detection of low density foreign objects floating in the product.

Remarkable detection accuracy

Certain identification of transparent foreign objects even in non-transparent liquids.

Improved sharpness

Optional doubling of the resolution for the reliable detection of minute faults.

Straightforward integration

Add-on module for a problem-free connection to fill management systems such as the HEUFT SPECTRUM II VX.



HEUFT spotter II SF

Foreign body inspection for the reliable detection of dangerous low-density objects based on the HEUFT SPECTRUM II.

Maximum product safety

Reliable detection of faults which are hardly visible to the naked eye such as mould on the base, transparent film fragments floating in the product or cracks in the glass.

Exact orientation

Servo-controlled bottle alignment for a continuous 360° all-around inspection.

Full transparency

Unique optical technologies and HEUFT reflex^{A-1} real-time image processing for the reliable detection of foreign bodies even in cloudy or dark products.

Specific object detection with teach-in

Highly automated HEUFT SPECTRUM II platform with audiovisual HEUFT NaVi user guidance for more performance and precision during product tracking, foreign object detection and fault rejection.



Discover more

72 up to
containers per hour



OPTIONALLY WITH DOUBLED RESOLUTION



ADDITIONAL MODULE

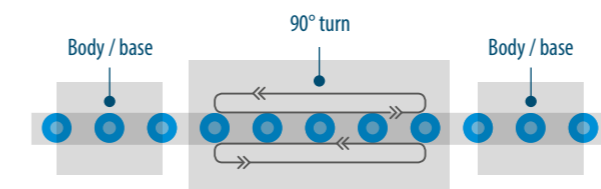

Film even detectable in cloudy or dark products.



72 up to
containers per hour



Discover more

Our devices for a leakage check

From internal container pressure measurement to the identification of microleaks.

Leak identified. Danger eliminated.

Leaks are a real safety risk. They not only cause unwanted product discharge but also threaten the microbial purity and harmless consumption of sensitive drinks. HEUFT solutions for checking tightness detect minute leaks just as precisely as faulty, untight closures and remove the bottles in question reliably. Therefore only full containers which are really leakproof reach the consumer.

High packaging quality and high product safety

Sustainable safeguarding of the container stability and effective protection against microbially contaminated drinks.

Full shelf life for full enjoyment

Effective prevention of premature product spoilage.

Clean surroundings

No sticky contamination on the line, during transport or at the point of sale caused by an unwanted product leakage.

Maximum product quality

Correct nominal filling quantity and high closure integrity.



DETAILED LEAKAGE CHECK:
identifying tiny leaks reliably.

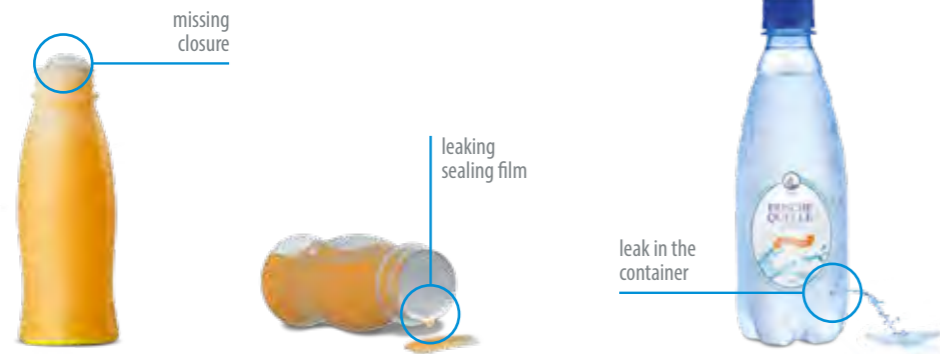

HEUFT *squeezer* II

Flexible leakage check based on the highly automated HEUFT SPECTRUM II platform.

Tight plastic bottles, pure contents

Reliable detection of the smallest leaks due to micro-cracks in filled bottles made of PET, PE, HDPE and other plastics to sustainably ensure the integrity of the packaging for aseptic, microbially pure end products.

Full stability

Precise measurement of internal container pressure for tight, stable, optimally transportable and storable full products.

Outstanding detection reliability

Comparative fill level check in depressurised and pressurised condition for reliable identification of leaks. Quantifying pressure analysis and permanent filling management.

Precise micro-leak detection and full closure safety

Flexibly extendable inspection path for even more precise detection of micro-leaks barely visible to the naked eye.

Directly integrated HEUFT FinalView II CAP modules for a detailed all-round inspection of the closures and all their safety elements. Reliable detection of leaking film closures.

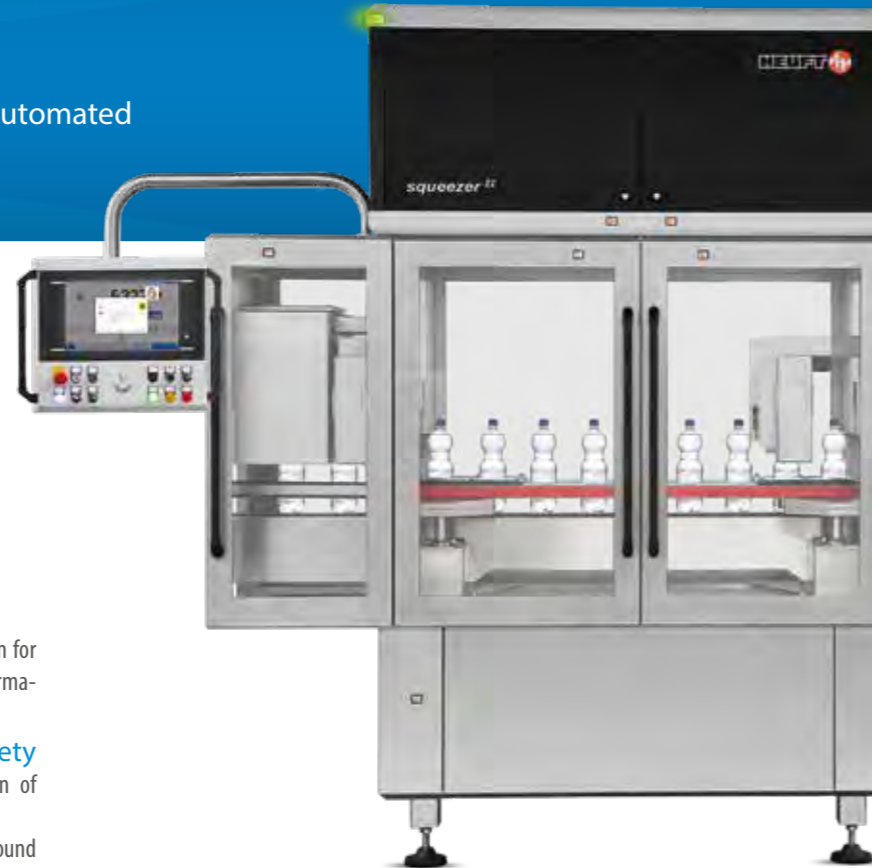

HEUFT *exciter*

Ultrasonic fobbing for examining whether the closure leaks.

Complete closure safety

Protection against product spoilage and product leakage as well as ensuring the stability of PET bottles.

Direct transfer and full productivity

Ultrasonic generator for product fobbing directly on the conveyor instead of a productivity thwarting water bath.

Careful examination

Zero pressure, almost frictionless gliding of the containers along the oscillating guide rail.

Compact solution

Space-saving and easy to retrofit detection unit.



72,000 up to
containers per hour

Optional extended inspection path.

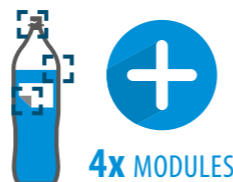
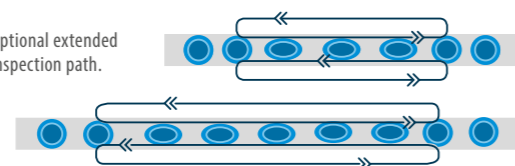

ADDITIONAL MODULE

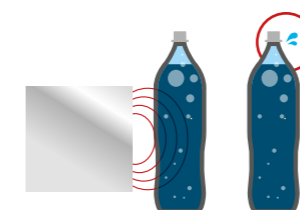

PRODUCT FOAMING DIRECTLY AT THE CONVEYOR

72,000 up to
containers per hour



Discover more

Our devices for an outer appearance inspection

From label to closure inspection.



Perfectly labelled. Securely sealed.

The appearance has to be right. Mislabelled containers and those which have not been correctly sealed must not reach the market in the first place. HEUFT end of line systems detect the beverage packaging in question and remove it from the line in good time. For this they carry out a detailed inspection of the labels, markings and closure elements which uncovers even minute deviations.

Attractive dress

Sustainable safeguarding of the perfect appearance of full containers due to a highly precise label inspection and the reliable rejection of mislabelled bottles.

Complete safety

Reliable identification and rejection of wrongly marked and incorrectly sealed bottles for maximum packaging and product integrity.

Optimal detection

Detection pictures without shadows or reflections during a continuous 360° complete inspection.

Reliable final examination

Compact end of line solutions for a sustainable quality assurance of the fully dressed final product.



PERFECT DRESS:
examining labels, designs, markings and closures carefully.



HEUFT *FinalView FO6*

Continuous final examination of the bottle dress.

Perfect appearance at the point of sale

Highly precise identification of non-brand, incorrectly positioned, scratched, creased, misprinted and dirty labels.

Clear marking

Detailed inspection of the design and lettering of all the labels, BBD verification with automatic date adaptation and barcode reading.

No blind marks

Continuous 360° inspection without reflections or shadows even when the containers are not aligned.

Genuinely sealed

Examination of the presence, colour and logos of the closures.



HEUFT *FinalView 11 LBL*

Detailed label inspection based on the highly automated HEUFT *SPECTRUM 11*- for perfectly dressed end products.

Faultless appearance

Gapless complete inspection of all the labels and design elements as well as the reliable identification and rejection of incorrectly dressed bottles.

Maximum detection reliability

Reliable detection of crooked, non-brand, creased and torn labels as well as the clear identification of design faults due to superior optical technologies and the HEUFT *reflex A.I.* image processing system with teach-in assistant.

Optimal adaptation

Adaptive LED illumination for detection pictures without shadows or reflections and optional add-on cameras for different container types and sizes.

Full automation and maximum operational reliability

Highly automated, network-compatible HEUFT *SPECTRUM 11* platform for simple brand changes with no manual effort and simply more performance during a precise container tracking, inspection and rejection. Audiovisual HEUFT *NaVi* user guidance for error-free, tamper resistant operation.



72,000 up to containers per hour

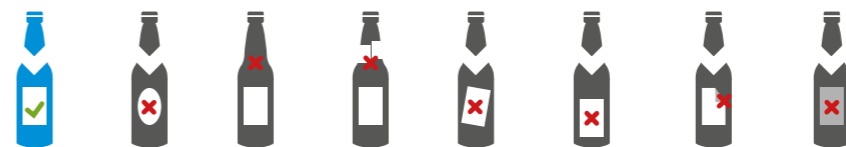
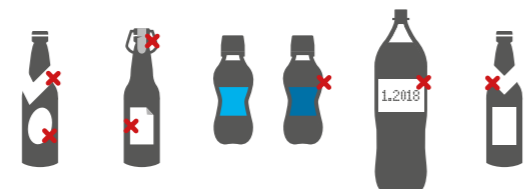

72,000 up to containers per hour





Real-time product tracking and reject verification

PRECISE MONITORING FOR FULL DETECTION RELIABILITY!

Where is the bottle? You should know this. The exact current location of a particular container on the line has to be known at all times. A reliable inspection and fault rejection is only then possible.

The distance covered and the position of each individual beverage packaging unit is triggered repeatedly and tracked precisely on the conveyor.

Precise real-time monitoring is the guarantee for full detection reliability.

It locates the exact location of all the containers constantly with millimetre accuracy. This ensures that each individual one is really examined and each faulty one is actually removed.

Permanent product tracking guarantees maximum accuracy when rejecting faults.

Only those bottles, cans and composite packages which really have to go are removed. The monitoring procedure even goes a step further: the integrated reject verification records immediately if a fault which should be rejected has not left the line yet.

ENLIGHTENMENT



HEUFT *FinalView* II CAP

Detailed closure inspection based on the HEUFT *SPECTRUM* II.

Full closure safety and maximum product integrity

Continuous all-around inspection of closures and their safety elements.

Superior detection accuracy

Reliable identification of non-brand, canted, defective, leaking and incorrectly positioned closures as well as the clear detection of thread faults and damaged tamper evident and neck rings.

Individual and flexible

Different detection modules for specific requirements from finding bull-noses, inspecting colour logos to checking the closure alignment with millimetre precision.

Highly automated and self-explanatory

Brand changes at the push of a button and audiovisual step-by-step assistance for utmost operational reliability.



1.4 x
more performance

1.5 x
larger height difference

1.2 x
wider closure diameter

6 x
higher resolution

99,000
containers per hour



Discover more

PRECISELY APPLIED & PERFECTLY DRESSED

Aligning, applying and standing out – labelling
filled beverage packaging exactly.



Our new generation of labelling machines.

From wet glue to wrap-around labelling.



Faultless dress. Optimum appearance.

Aligning, applying and standing out: the labelling machines of the HEUFT *TORNADO II* series make this possible! They carry out a clean and exact application of filled containers with attractive wet glue, hot glue, wrap-around and self-adhesive labels in the smallest of spaces with even more performance, dynamism and flexibility. The labellers based on the network compatible, highly automated HEUFT *SPECTRUM II* platform can be equipped with several different labelling stations flexibly, partly retrofitted especially quickly and easily and even operated by voice! In addition easy to integrate add-on modules check the quality of the newly labelled full container in the same process.

Full information

Reliable, optimally readable information about the product inside due to brand consistent, error-free labelling.

Perfect look

Attractive container dress for a high recognition value at the POS and sustainable brand protection.

High-precision application

Extremely precise labelling without creases, bubbles or offset due to *flex* technology for an accurate servo-controlled fine alignment of the bottles and the new HEUFT *SPECTRUM II* performance.

Versatile procedures

Accurate wet glue, hot glue, self-adhesive and wrap-around labelling of a wide range of container shapes and areas.



TIDILY AND ACCURATELY LABELLED:
applying labels exactly and without faults.



HEUFT *TORNADO II dynamic*

New generation of labelling machine without machine table which can be dynamically equipped and retrofitted (with integrated hands-free voice control).

Simply more dynamism and flexibility

The first easily accessible HEUFT compact solution without machine table for easier and more flexible equipping and retrofitting with up to four wet glue, wrap-around and self-adhesive labelling stations as required.

Accurate application and integrated quality inspection

Integrated detection modules for a camera-based, servo-controlled HEUFT *TORNADO II flex* fine alignment of the containers for particularly accurate labelling results as well as, among other things, a direct labelling, fill level and closure check, BBD and code verification.

Uncomplicated brand and program changes

Replacement of change parts without tools, automatic adjustment of the machine head and detection modules as well as a rotating cam which can be programmed according to the brand. Easier integration of additional units and procedures for greater flexibility regarding container dress with different types of labels.

Genuinely responsive performance

Highly automated HEUFT *SPECTRUM II* device platform for considerably more performance when tracking containers, labelling, identifying faults and rejecting. Audiovisual HEUFT *NaVi* user guidance and new dialogue function for voice control of the machine.



HEUFT *TORNADO II classic*

Versatile labelling machine based on the HEUFT *SPECTRUM II*.

Perfect dress

Accurate application of body, collar, back, neck ring and closure labels with up to three permanently mounted wet glue, self-adhesive or wrap-around labelling stations. Optionally with the HEUFT *TORNADO II flex* servo technology for a precise camera-based fine alignment of the containers for simply perfectly positioned labels.

Integrated check

Examination of the label presence in the same process. Straightforward integration of further detection modules e.g. for a fill level, closure and marking check.

Uncomplicated brand change

Replacement of change parts without tools, automatic adjustment of the machine head and detection modules as well as a rotating cam which can be programmed according to the brand and is reproducible at any time.

Durable construction on a new platform

Low maintenance requirements due to the proven robust construction of the HEUFT *CleanDesign*. Highly automated HEUFT *SPECTRUM II* platform with the audiovisual HEUFT *NaVi* user guidance and optional hands-free voice control for simply more labelling performance and operational reliability.



Wet glue units not electrically but mechanically coupled for the parallel use of several stations in one machine.



Discover more

72 up to
containers per hour

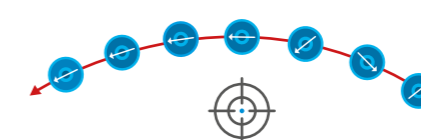
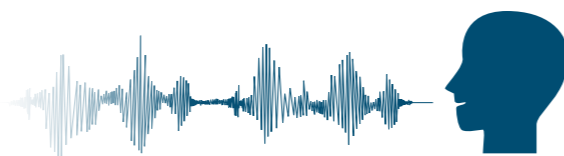
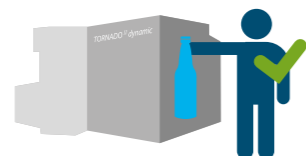

72 up to
containers per hour



Discover more

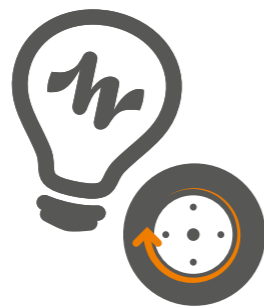

HEUFT *TORNADO* " flex servo technology

EXTREMELY EXACT AND EXTREMELY EFFICIENT!

First-class labelling results, particularly easy brand changes and considerably less wear and tear: servo labelling machines of the HEUFT *TORNADO* " series achieve a maximum amount of precision, flexibility and profitability during the application of labels.

The integrated servo technology carries out a fine alignment of the containers with millimetre accuracy. Typical characteristics such as closures, embossing and even hairline mould seams are detected by camera and used as alignment marks for this purpose.

Therefore the labels end up exactly where they belong.

In addition the servos ensure a specific, reproducible rotating cam for each individual container format for clean and crease free labelling. The complex mechanical replacement of the individual cam segments is not necessary:

brand and program changes are accomplished in next to no time!

The same applies to the addition of new equipment variants.

The servos have lifetime lubricated bearings and no gears making them practically wear-free. This makes their use in the new generation of HEUFT labellers extremely economical.

ENLIGHTENMENT



Wet glue labelling units

Tidy application.

Self-adhesive labelling units

Simply off the roll.

Wrap-around labelling units

Controllable rotation.

All the labellers of the **HEUFT *TORNADO* "** series can be equipped with several compact, electrically coupled wet glue stations e.g. for body, collar or neck labelling. The containers are guided past them after they have been transferred to the carousel and fixed by the centring elements.

At the same time the integrated glue segments are covered with an exactly adjustable quantity of glue so that each individual one picks up precisely one label whilst passing.

A gripper cylinder then pulls it off and presses it gently with the glued side against the precisely aligned container. A sponge ensures a homogeneous application.

Platforms which have their own gears rotate the containers so that the wet glue labels are always applied tidily and brushed on without creases. The optionally available Automatic Magazine Feed (AMF) ensures that their supply does not run out too quickly and prevents production stops.

Self-adhesive stations which can be integrated into the **HEUFT *TORNADO* "** labelling machines easily apply self-adhesive labels with a perfect and close fit.

The containers enter the labeller if the container stop which stops the production flow in the case of a malfunction is unlocked. The infeed worm ensures that the gap between them is correct in the course of this before they are taken over by the infeed starwheel and transferred to the machine carousel.

This is exactly where the self-adhesive labels are applied. The roll with the labels is placed in the labelling unit for this. Thus they can be peeled off at the dispensing plate and applied to the passing containers using special pads. They are firmly clamped for this – in fact in the centre between the rotating platform and the centring bell. Therefore nothing can slip and the labels remain stuck exactly where they belong.

Special units can be integrated into the **HEUFT *TORNADO* "** machines easily and flexibly for wrap-around labelling – with individually controllable nozzles which apply fine spots of glue in the right quantity and exactly to the containers fixed in platforms by means of centring bells.

A servo-controlled belt drive rotates the containers harmoniously at a speed which can be specifically regulated for different formats so that the labels can wrap themselves around them completely and precisely. The glue spots which have been applied pull the labels out of the magazine. At the same time a special nozzle applies a thin line of glue to the end of the label for the final gluing so that the overlap can be stuck precisely practically without an offset and brushed on carefully.

A closed hot glue system keeps glue consumption low and prevents contamination. This reduces maintenance costs and increases operational reliability during the accurate application of wrap-around labels.

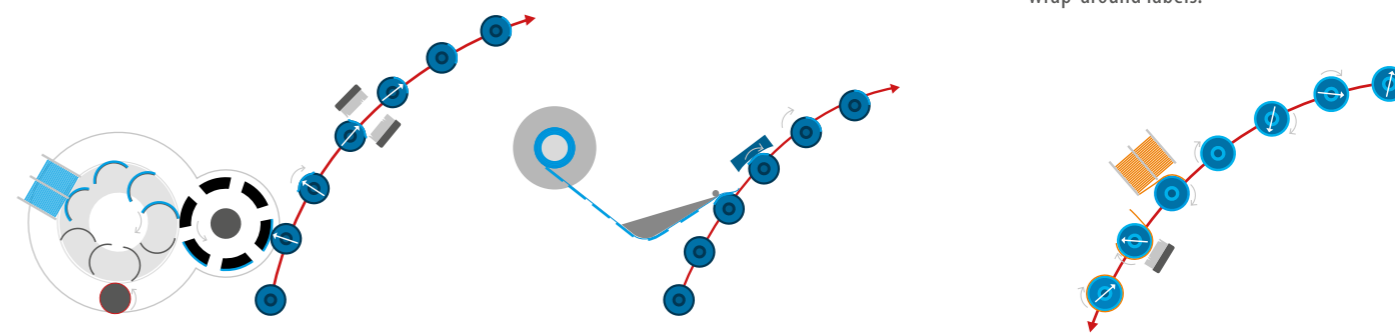



EVERYTHING FLOWING SMOOTHLY AND EVERYTHING UNDER CONTROL

Powering, regulating and rejecting – transporting bottles and cans without faults through the line efficiently and carefully / removing faulty containers from the line consistently.

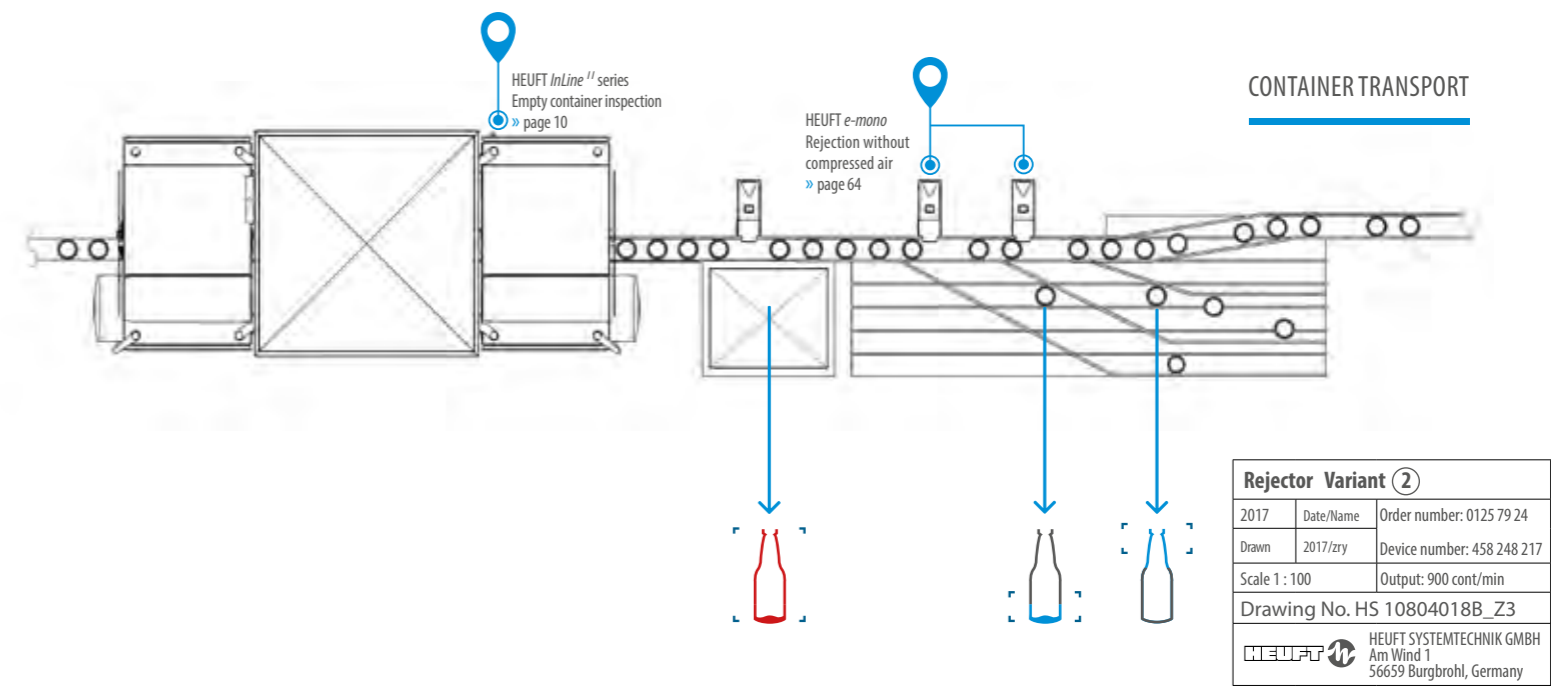
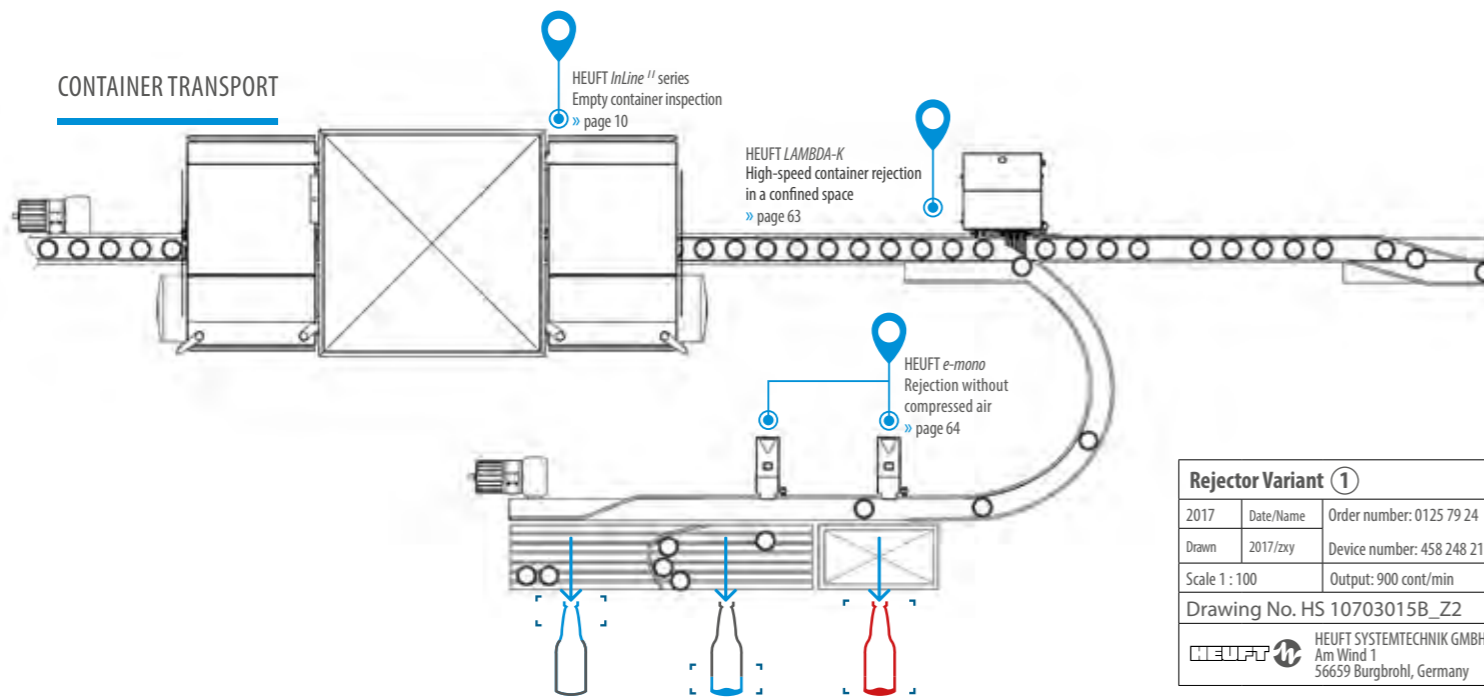

Our container transport solutions

From conveyor drive to fault rejection.

No impact pressure and no gaps. Full line efficiency.

Continuous, careful and without pressure: this is what really matters regarding the container flow along your filling and packaging line. After all, the master machines should be continuously supplied, jams prevented and all the products transported fast, safely, smoothly and quietly. You will achieve a harmonious, efficient container flow without interference or impact pressure, even in the high-speed section and in a confined space, with drives, conveyors and conveyor control systems from HEUFT. This protects the quality of the product and the packaging and at the same time increases the efficiency and productivity of the complete line.

Efficient drive

Energy-saving motors with high efficiency for dynamically driven conveyors.

Gentle transport

Tailor-made single-lane and multi-lane conveyors.

Intelligent control system

Proactive conveyor control system for a harmonious container transport without gaps or impact pressure.

A high degree of flexibility

Specific solutions for the most varied requirements regarding line optimisation.

Everything flowing smoothly and everything in order!

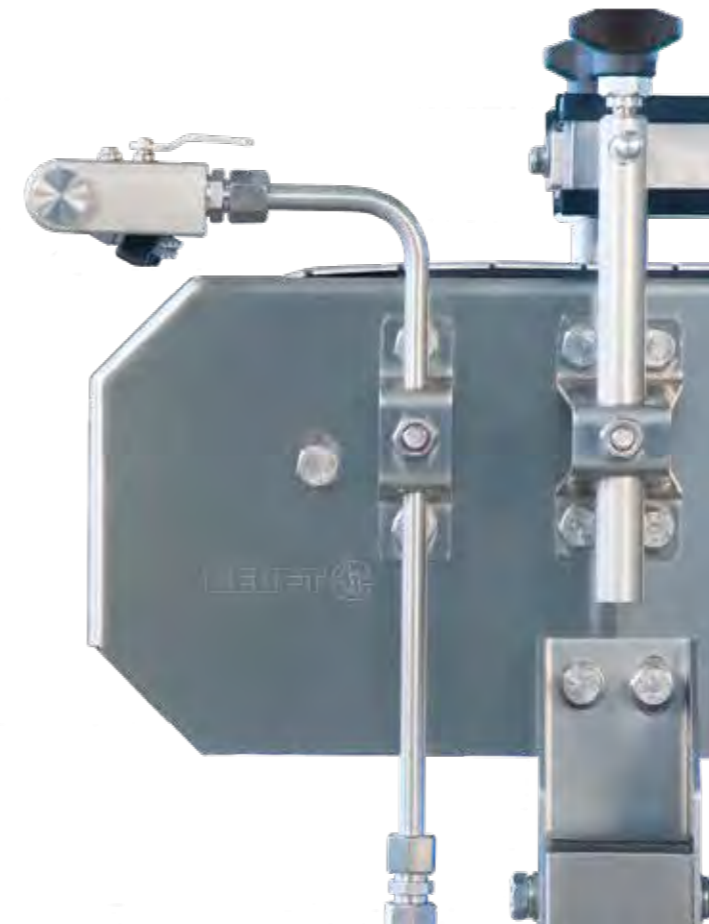

From single-lane to multi-lane transport, from a primary rejection to a fault-specific secondary removal: you can achieve a smooth and efficient product and container flow in a small area with drives, conveyors, conveyor control systems, rejection systems, buffer tables, individually adapted layouts and unique complete solutions from HEUFT!

Space-saving, flexible and individual

Detailed line analyses, intensive advice and exact planning by competent HEUFT experts create compact solutions which will even fully meet your specific requirements! Products without faults are thus transported carefully through the line so that they remain without faults. Faulty ones are removed specifically and reliably – either by means of a primary rejection directly from the main flow and a subsequent fault-specific secondary removal ① or little by little ② at various positions after the inspector.



HEUFT conveyor

Powerful conveyors for a safe container transport.

Optimal conveying

Fast, safe and careful transport of empty and full containers on one or several lanes.

Problem-free integration

Customised adaptation to individual space available and requirements due to a flexible combination of a variety of standard modules and curve radii.

Construction optimised for maintenance and cleaning

Robust components, adjustments without tools, no "dirty corners" and hardly any contact surfaces for germs.

Comprehensive advice and planning

Full HEUFT expertise from situation analysis to the specific implementation of individual transport solutions and sustainably optimised line layouts.



**HIGH-SPEED
CONTAINER
TRANSPORT**



Discover more

HEUFT synchron¹¹ BS

Conveyor regulation for an uninterrupted supply to the master machines.

Intelligent control system

Space-saving module for the harmonious and precise adjustment of the critical single-lane conveyor sections – from unmatching via a HEUFT inspection system which can be optionally integrated to the infeed of the master machine.

Zero-pressure gap closing

Gentle closing of gaps in the container flow without impact pressure or hard, noisy collisions for a continuous supply to the master machine. Proactive prevention of tailbacks.

Adjusted transport

Precisely adapted conveyor speeds for gently accelerating or carefully decelerating the container flow for a pressureless combining process and efficient transport free of jams.

Easy integration

Cost-optimised module for decentralised assembly directly at the conveyor with compact, flexibly positionable HEUFT ONE control terminal. Uncomplicated integration into existing filling and packaging lines. HEUFT can also supply the complete corresponding power electronics on request.

HEUFT synchron TXI

Conveyor control system for a harmoniously regulated, efficient container flow.

Increased efficiency

Smooth, zero-pressure gap closing – proactive prevention of jams, blockages and line stoppages.

Continuous supply

Single-lane blocking of master machines for maximum efficiency.

Harmonious mass transport

Careful control of multi-lane conveyors, pressureless regulation of the buffer areas and reliable container distribution.

Stress-free flow

No glass defects caused by hard collisions and impact pressure, less scuffing and considerably reduced noise.



Smooth gap closing

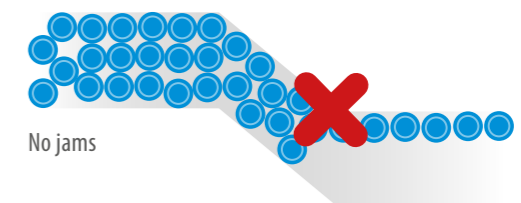

No jams



Discover more



HEUFT LAMBDA-K

Upright high-speed container rejection in a confined space.

Slim alternative to conventional rejectors with bulky rejection tables

New, particularly compact complete system comprising special conveyor mechanics, intelligent conveyor control system and modified HEUFT DELTA-K multi-segment rejector.

Safe rejection without falling over

Smooth upright rejection of faulty / non-brand bottles and cans due to special segment curve for minimum container resistance.

Compact conveyor instead of bulky buffer table

Gentle diversion of faulty containers onto a space-saving single lane rejection conveyor.

Trouble-free changeovers and fast brand changes

Simple adjustment and precise vertical and horizontal settings with a digital display.

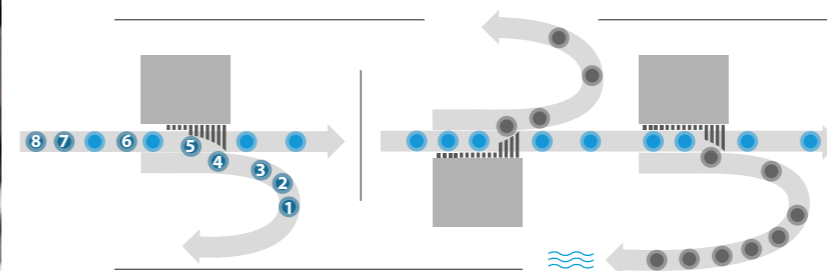

60,000
up to
containers per hour

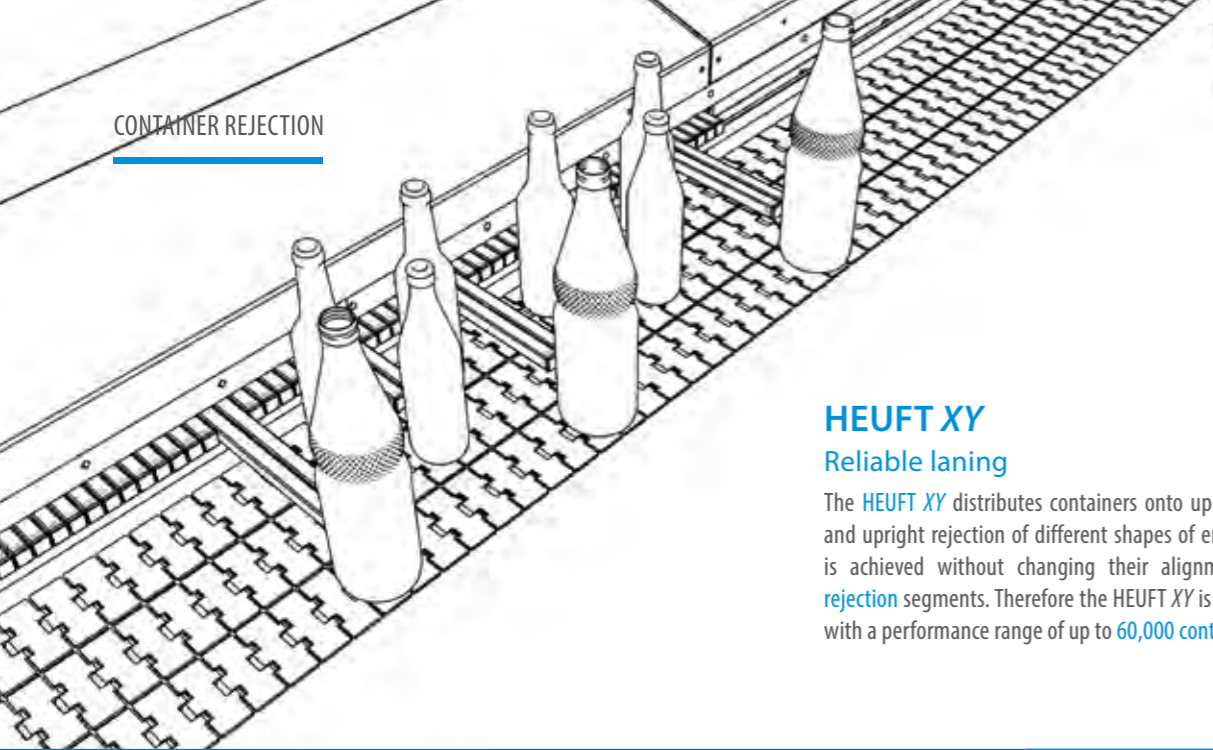

Discover more

**HEUFT XY****Reliable laning**

The **HEUFT XY** distributes containers onto up to four lanes. The sorting out and upright rejection of different shapes of empty and full bottles and cans is achieved without changing their alignment due to **servo-controlled rejection** segments. Therefore the HEUFT XY is ideal for use on beverage lines with a performance range of up to **60,000 containers** per hour.

**HEUFT pusher**

Compact discharger.

HEUFT mono

Careful rejector.

HEUFT e-mono

High-speed rejector without compressed air.

HEUFT flip

Smooth rejection.

HEUFT DELTA-FW

Dynamic rejection curve.

HEUFT DELTA-K

Gentle folding rejector.

The **HEUFT pusher** transports faulty full containers by means of a carefully calculated push to where they belong: in the rubbish. The **single-segment rejection system** works precisely and reliably even on high-speed lines with conveyor speeds of up to 2.5 metres per second and a maximal output of **125,000 containers** per hour. The compact HEUFT pusher shows its true qualities on filling lines for drinks cans.

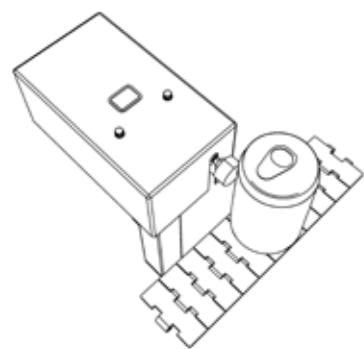

The **HEUFT mono** removes full and empty containers with safety and quality defects reliably. And carefully. A special guide rail on the single segment rejector compensates the static friction of the containers for this. Consequently full bottles can even be rejected upright using **minimum segment movement** and without falling over. The HEUFT mono, a cost-effective all-rounder, is suitable for line outputs of up to **72,000 containers** per hour.

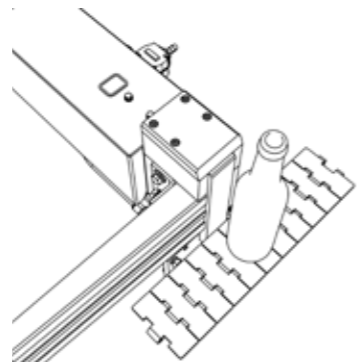

The **HEUFT e-mono** is ideal for rejecting faulty containers onto a parallel conveyor or directly into a bin. The almost wear-free system does not need expensive, unhygienic compressed air for this and electricity only during the rejection procedure. Its feed force is adapted to the respective weight so that packaging material where the contents vary considerably is nevertheless rejected over the same distance. And that at line outputs of up to **180,000 containers** per hour!

The **HEUFT flip** removes all formats of empty and full bottles gently from the filling line. The unprecedented low mechanical load of the lifting cylinder which sets the rejection segment in motion is due to a cleverly designed joint construction. The compact HEUFT flip is ideally suited for the upright rejection of lightweight cylindrical beverage packaging for line outputs of up to **60,000 containers** per hour.

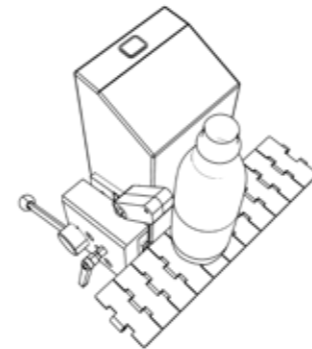

The **HEUFT DELTA-FW** rejects and distributes filled bottles and cans upright. Up to sixteen segments form a rejection curve along which they are gently guided. When a good container follows a faulty one only the first container is touched. The system carries out the reliable **rejection of complete series** with permanently extended segments. And that at line outputs of up to **150,000 containers** per hour.

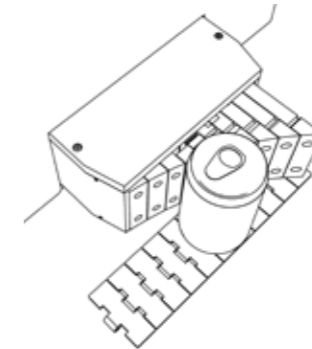

The **HEUFT DELTA-K** is ideally suited for sorting out empties upright, distributing empty and filled containers as well as rejecting complete series. It has up to 16 segments which can be **folded out individually so quickly** that unsuitable containers can be rejected unproblematically without touching the preceding or subsequent containers. It only rejects that which has to go at line outputs of up to **72,000 containers** per hour.

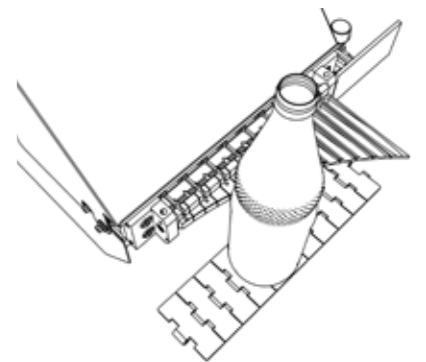



CORRECT BRAND & FUNCTIONAL

Examining, measuring and evaluating – ensuring the brand purity, quality and effectiveness of returnable crates, cardboard boxes for drinks and trays sustainably.

Our devices for an empty case inspection

From a non-brand bottle detection to a crate design examination.

Perfect inside. Outside too.

Unmixed, intact and safe to unpack: returnable crates should not contain too many non-brand bottles and no foreign objects whatsoever, not pose a risk of injury, be straightforward to empty and look their best. HEUFT systems for a detailed empty case inspection and rejection ensure this. Therefore only perfect returnable crates are re-used. The result: top quality end products and maximum line efficiency.

No mixing up

Timely rejection of empty crates with a large number of non-brand bottles.

Full unpackability and functionality

Specific examination of the crate geometry.

Ultimate consumer safety

Reliable detection of injury risks such as broken handgrips.

Perfect look

Complete crate design inspection capable of learning for optimum appearance at the point of sale.



COMPLETELY AND PERFECTLY PACKAGED:
examining secondary packages precisely.

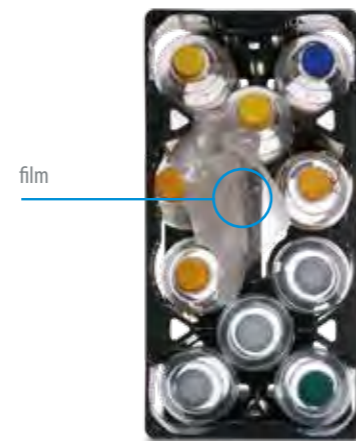
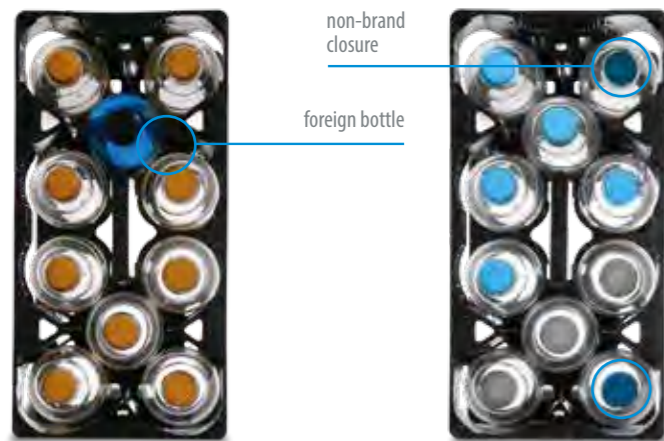

HEUFT LX

Returned case inspection for drink crates free of non-brand bottles and faults.

Full brand purity

Reliable identification of non-brand bottles, clear differentiation between glass and PET and the consistent rejection of excessively mixed crates.

Maximum safety

Full unpacking suitability and minimised risk of injury due to the clear detection of distorted cases, broken handgrips and foreign objects.

Optimal appearance

Reliable detection of foreign crates due to precise colour and logo check.

Minimum false rejection rate

Accurate rejection due to the combined evaluation of all the measuring results using fuzzy logic (see the infographic).



HEUFT LKX

Specific examination of the crate design.

Perfect appearance at the point of sale (POS)

Continuous complete inspection of all four outer walls of empty drink crates for the reliable identification of damage, label remains, contamination, marking and design faults.

Implementation of individual quality requirements

Targeted characterisation of detected objects as acceptable deviations or unwanted defects due to the HEUFT *reflexx*² real-time image processing system with teaching in capability.

Reliable removal of faulty crates

Safe tracking and precise rejection of faulty crates including reject monitoring.

Easy brand changes

Automatic adaptation of all the parameters and motor-driven adjustment of the height and position of each of the detection units.



Discover more

up to **7,200** cases per hour



100%

Reference



85%

Good product



42%

Fault

Fuzzy logic: comparing apples with pears!

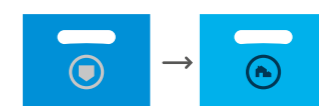

up to **7,200** crates per hour



Discover more

Our devices for a full case inspection

From checking product completeness to the complete inspection of secondary packaging material.



Safe secondary packaging material. In premium quality.

Complete, good to handle and attractive: secondary packaging material containing drink containers such as crates, cardboard boxes and trays has to fulfil these criteria in order to arrive at the point of sale safely and attract the full attention of the end customer there. HEUFT systems for the precise identification and consistent rejection of faulty full cases ensure this! Thus they detect and remove outer packaging with incomplete contents just as reliably as that which is contaminated, distorted, defective and cannot be transported or stacked.

Fully packaged

Clear detection and specific rejection of full cases with missing products.

Full detection accuracy

Precise detection of faulty beverage containers and foreign objects in a case.

Full shape

Reliable identification of distorted crates and cardboard boxes.

Full safety

Gentle rejection of faulty full cases.



COMPLETELY AND PERFECTLY PACKAGED:
examining secondary packaging material precisely.

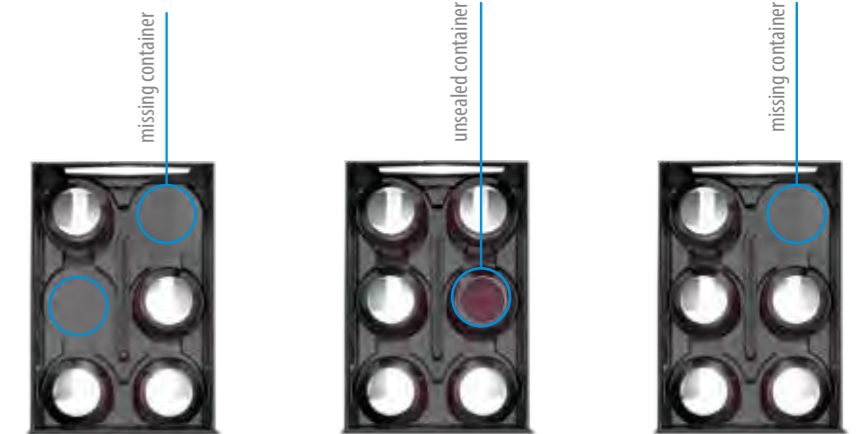
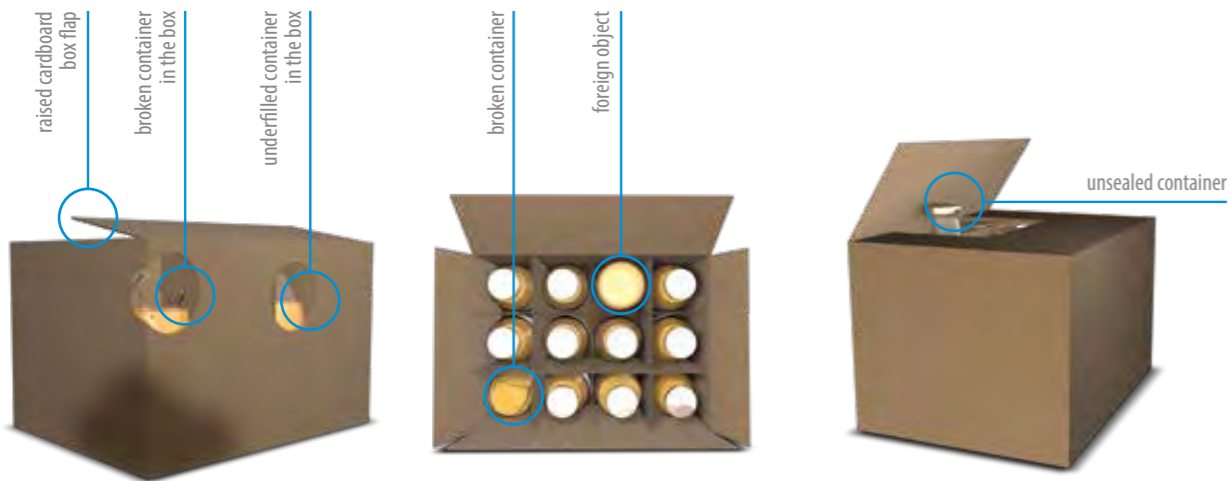

HEUFT GX

Full case inspection for outer packaging in top shape.

Extensive quality assurance

Detailed examination of filled drink crates, cardboard boxes and trays.

Complete unpackability and transportability

Reliable detection of distorted and incorrectly sealed full cases.

Fully packaged and the correct height

Reliable examination that the correct number of containers is present in the case and a height profile check for identifying distorted and contaminated compartments as well as faulty containers.

Specific fault rejection

Consistent removal of incompletely packaged, faulty and non-transportable full cases from the production flow.



HEUFT logic

Compact full case check for secondary packaging material with complete contents.

Continuous packaging quality

Reliable examination to check that all the containers are present in drink crates, cardboard boxes and trays using optical and electromagnetic procedures.

Precise detection

Reliable identification of incompletely filled full cases due to total coverage of up to eight compartment rows and columns.

Targeted sorting out of faulty cases

Conveyor stop signal or direct activation of a HEUFT case rejector.

Flexible adaptation

Height adjustable detection units for different case sizes – up to four pre-programmable brands.



Discover more

up to 7,200 cases per hour

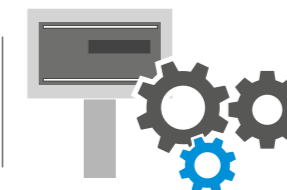
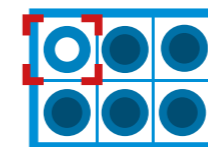
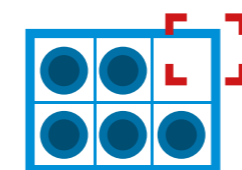

1,0 ms



Discover more

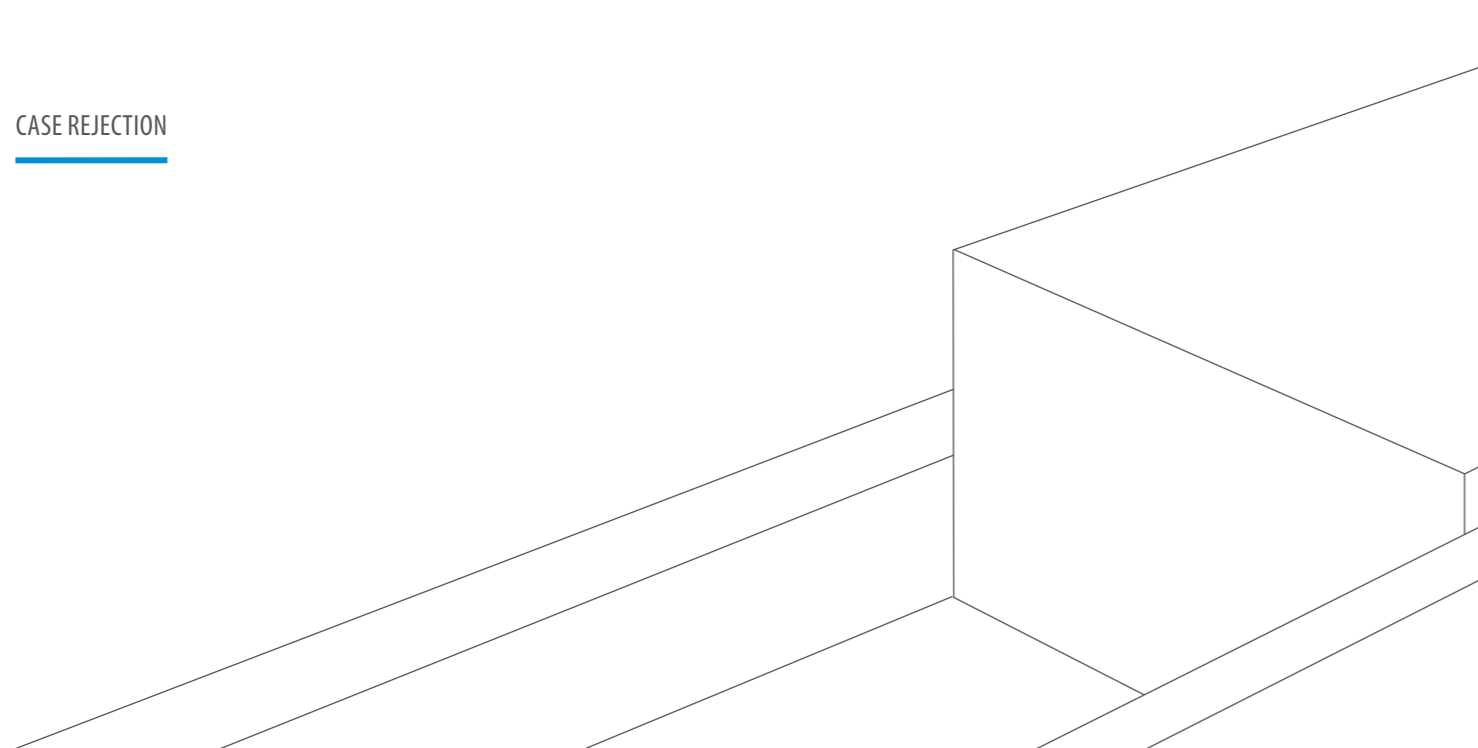

HEUFT *xcase*

Adaptable rejection push.

HEUFT *xtray*

Intelligent tray rejection.

HEUFT *maxi-flip*

Flexible activation.

HEUFT *maxi-laner*

Compact alternative.

The **HEUFT *xcase*** creates brand purity and quality on a line. Its load-dependent control system, which adapts the force of the rejection push to the weight of each individual case, removes non-brand or faulty outer packaging smoothly from the filling line. Cases of varying weights are therefore each rejected an equal distance.

The **HEUFT *xtray*** removes damaged or faulty full trays from the line. Three rejection fingers assembled on a sledge under the roller conveyor are extended for this purpose. Trays can also be distributed onto several lanes if several of these intelligent case rejectors are lined up next to each other.

The **HEUFT *maxi-flip*** rejects empty, half-full or completely full cases each an equal distance onto parallel conveyor chains. Its rejection segment is activated for a longer time for heavy cases or cardboard boxes than for lighter ones. A complex mechanical changeover for different types of cases is not necessary.

The **HEUFT *maxi-laner*** is even more space saving than the HEUFT *maxi-flip*. The system installed directly above the conveyor is also impressive with a load-dependent control system for the rejection of different cases. Also possible: a reliable distribution onto up to three transport lanes.

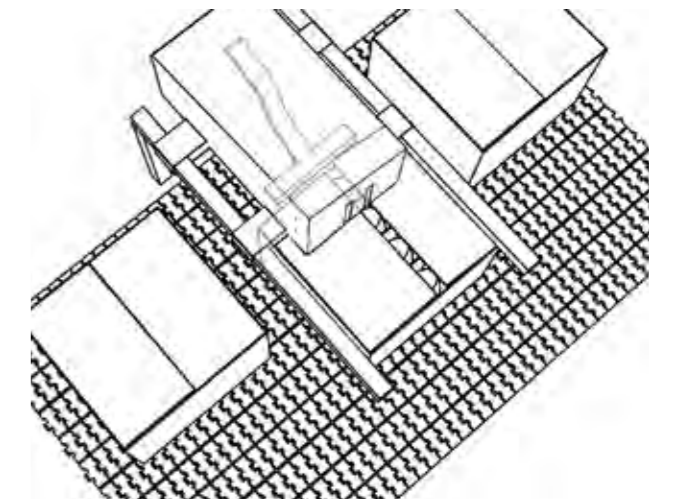
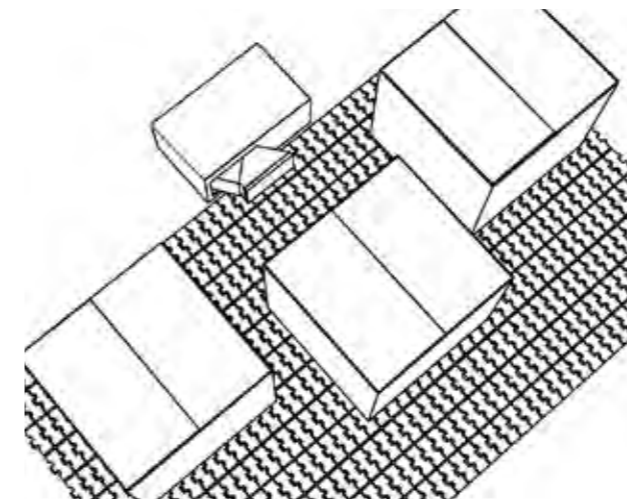
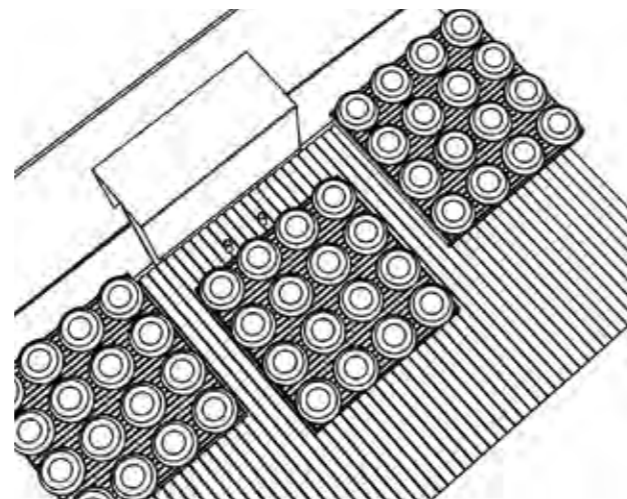
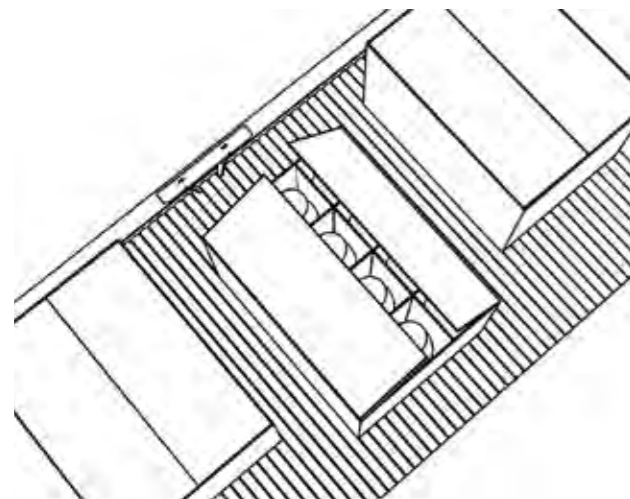

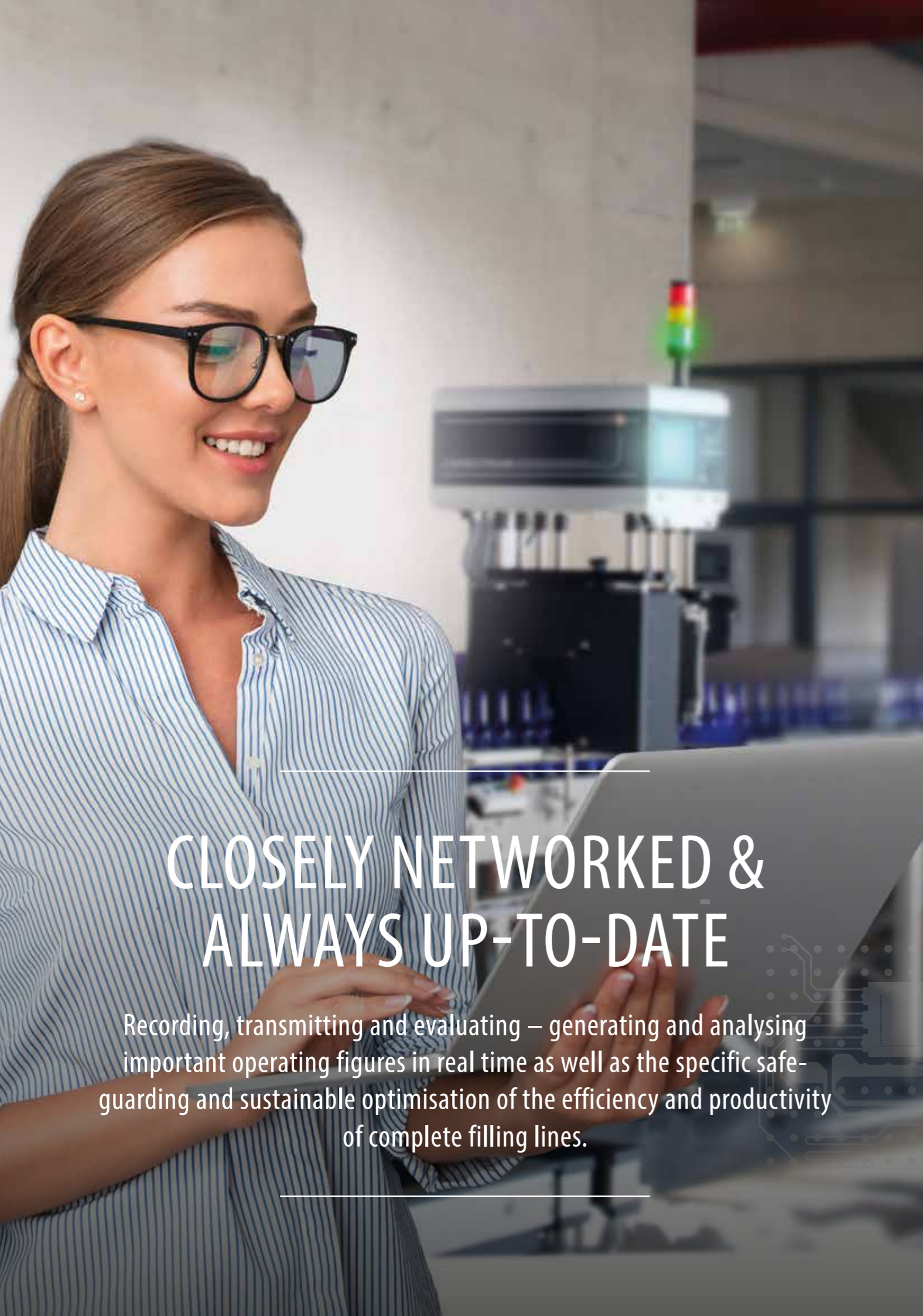

CLOSELY NETWORKED & ALWAYS UP-TO-DATE

Recording, transmitting and evaluating – generating and analysing important operating figures in real time as well as the specific safeguarding and sustainable optimisation of the efficiency and productivity of complete filling lines.

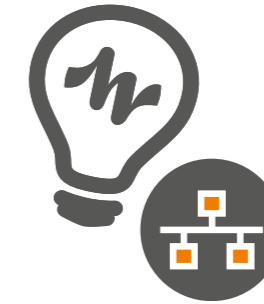

HEUFT network technologies

EVERYTHING NETWORKED AND EVERYTHING IN VIEW!

Transferring information, recording operating data, analysing the performance of complete filling lines, managing brands centrally and implementing targeted remote maintenance. HEUFT systems are equipped with future-proof network interfaces so that this all works in real time.

Open, standard and cross-platform protocols generate maximum efficiency and overview.

The devices and machines on a line have the same information, speak the same language and form a network into which office computers can also be integrated without a problem. Operating and production data, shift records as well as productivity, fault and HACCP limit value analyses are not only available at the HEUFT systems themselves but also everywhere in the network at the same time.

Interference, safety risks, quality problems and efficiency losses are therefore identified immediately.

A firewall protected direct connection to the HEUFT *TeleService* makes competent remote maintenance possible all around the clock in order to rectify these at an early stage.

The result: optimal efficiency and quality management.

ENLIGHTENMENT



Unpacker
 Washing machine
 HEUFT InLine™ DXS
 Filling machine
 Closing machine
 HEUFT eXaminer™ XAC
 HEUFT TORNADO
 HEUFT Final View FO6

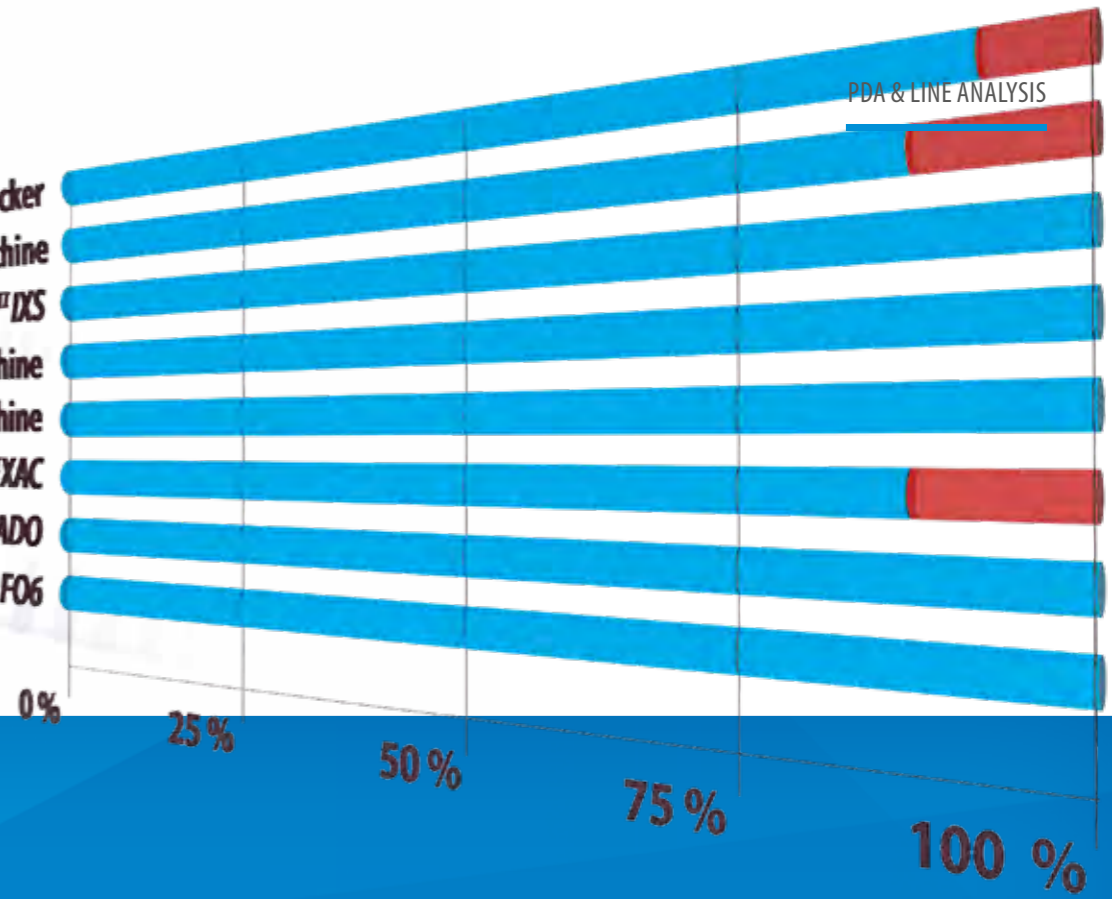

HEUFT PROFILER family

Production data acquisition (PDA) and line analysis in real time.



HEUFT STRATEGY II server for HEUFT PROFILER and HEUFT PROFILER advanced



HEUFT PROFILER elemental

Constant performance analysis

Continuous recording, sustainable backing up and targeted evaluation of production and quality-related data of HEUFT systems / all the networked machines of a packaging line.

More production quality and more productivity

Early exposure of error sources, weak points and interference for preventive maintenance.

Precise computing and clear display

Automatic calculation, table and graphic preparation as well as the long-term archiving of important operating figures.

Different versions for various requirements

Tailor-made, customer-specific tools from a slim software solution for the essentials to an extensive server-based complete line analysis.

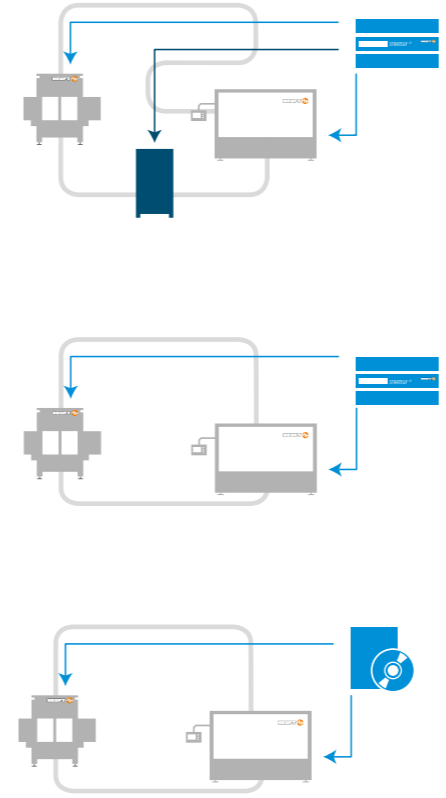

Extension

Upgrade

HEUFT PROFILER advanced
 The complete package for an extensive line analysis – server-based IT tool for HEUFT and non HEUFT devices

HEUFT PROFILER
 The PDA solution with added value – server-based IT tool for HEUFT devices

HEUFT PROFILER elemental
 Software solution for HEUFT devices – the PDA system for the essentials

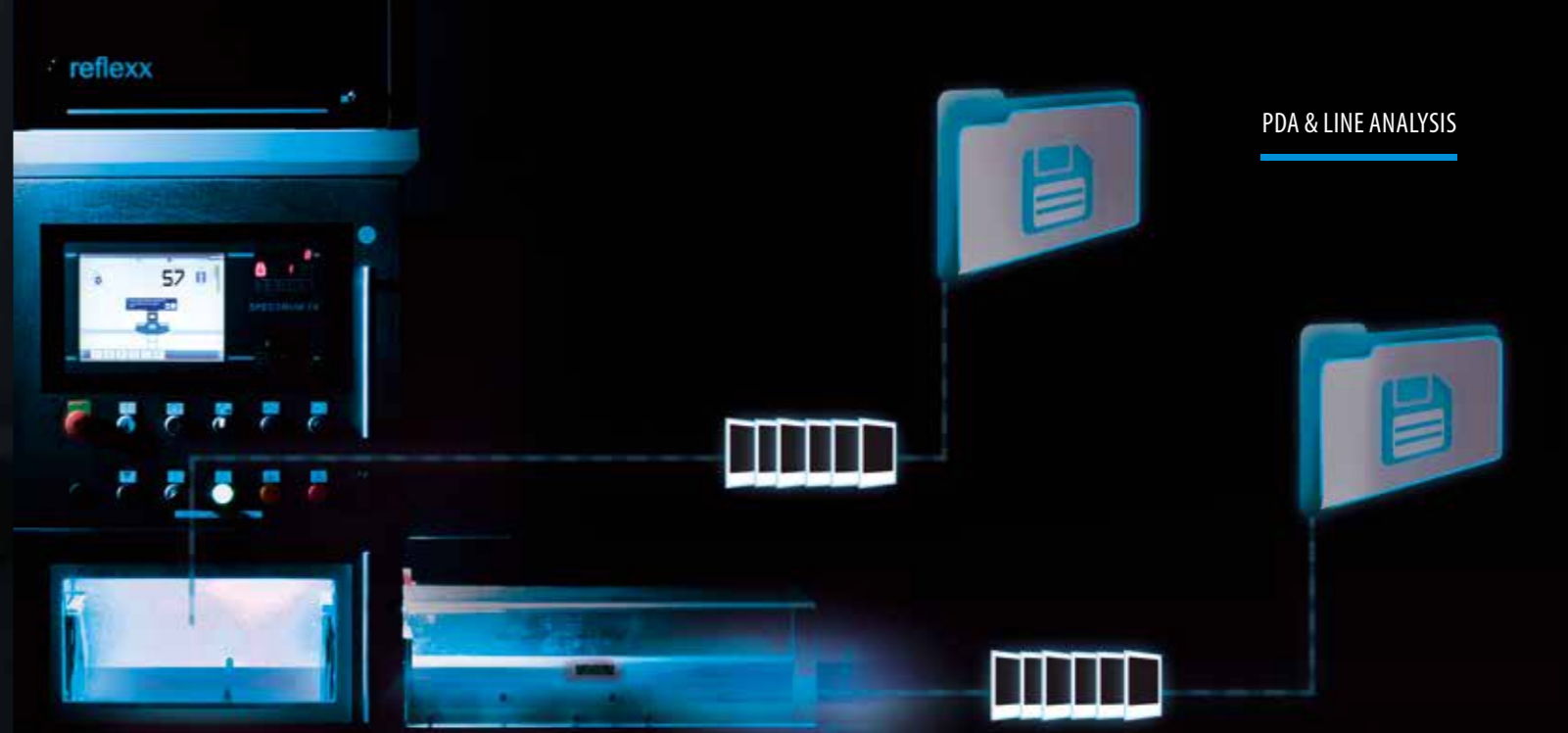
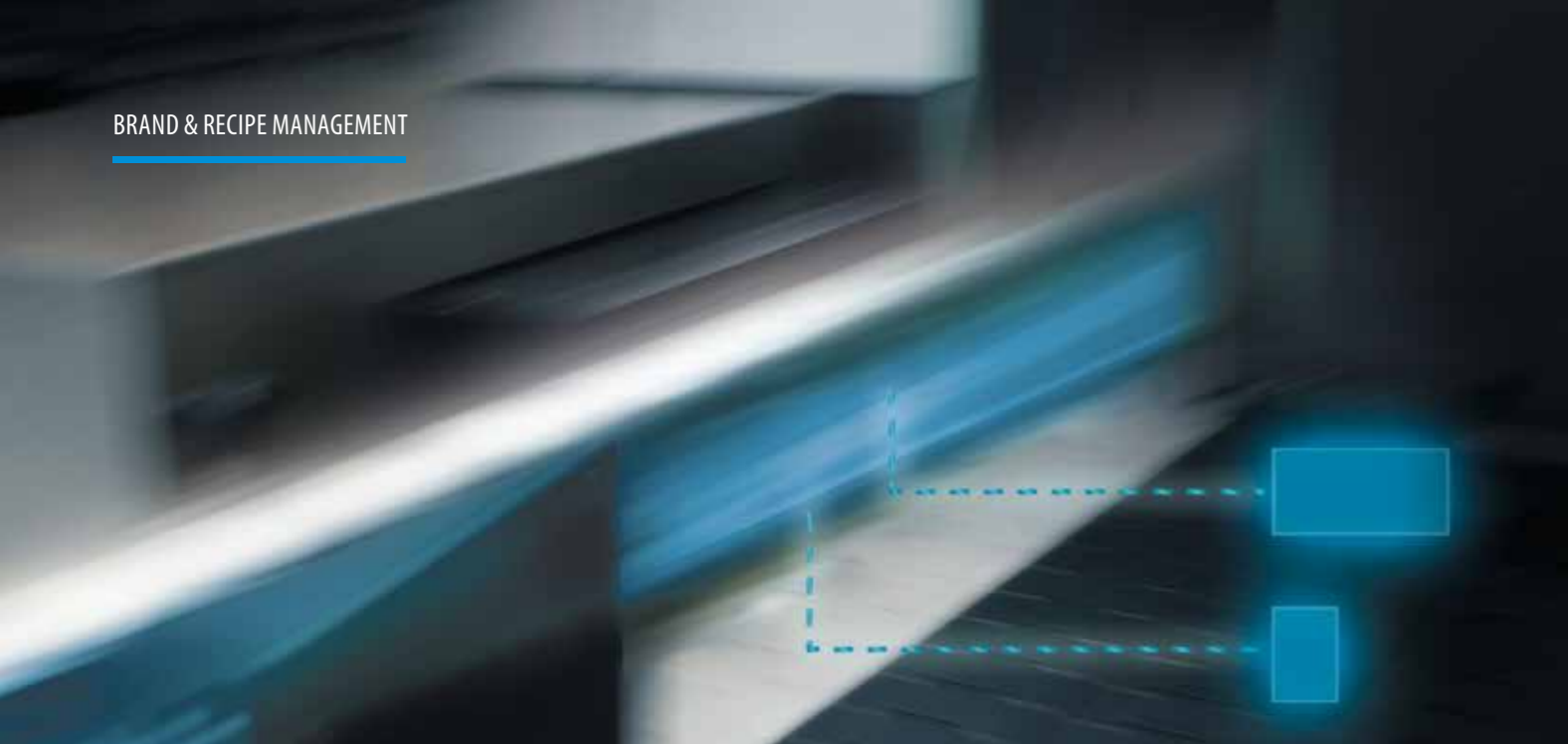

HEUFT *RECIPER*

Networked brand and recipe management.

HEUFT *picCollect*

Automatic transmission and storage of detection pictures.

More product quality and more output

Server-based brand and recipe management in real time.

Automatic transfer of recipes and equipment features

Live distribution of all relevant data and parameters to networked HEUFT systems for optimal quality assurance.

Central brand changeovers

Direct connection to overall manufacturing execution systems (MES) for easy initiation of program changes and real-time transmission of changed container and equipment characteristics to each HEUFT device in the network.

Easy new commissioning and modifications

Uncomplicated addition of new and fast adaptations to existing recipes and equipment features.



Specific production monitoring and sustainable archiving

Direct transmission and long-term backing up of the camera pictures and X-ray images of all the inspected or all the rejected products for continuously documenting the detection performance of the HEUFT systems.

Obvious marking for a full overview

Marking the faults recorded in the jpg image files clearly in red.

Easy integration

Slim software tool for uncomplicated installation on customer servers and office PCs.

Permanent availability

Constant backing up without a time limit.



Discover more

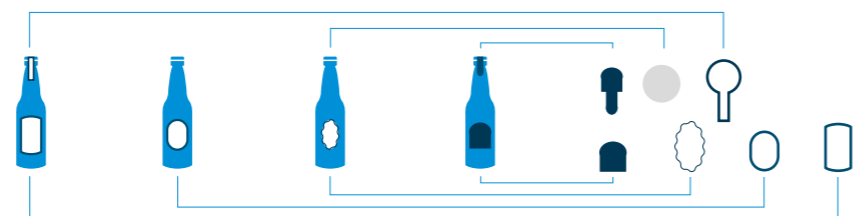

Archive

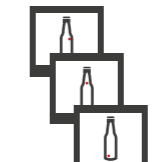

Archive



Discover more

LIFE CYCLE PARTNERSHIP

Those who choose HEUFT receive more than innovative systems which ensure product quality and line efficiency reliably. In HEUFT you have a strong partner at your side providing professional support from the very beginning.

We will bring in our full **expertise** before implementing turnkey solutions. Proactive **support** is provided by us at all times after commissioning. We simply always offer competent **enlightenment** regarding the possibilities and limits of an in-line quality inspection. The result: a reliable partnership which already begins prior to the purchase, extends over the complete life cycle of your HEUFT systems and ensures their full **performance** sustainably.

This minimises the total cost of ownership (TCO) and generates simply more added value, competitiveness and productivity with maximum product quality!



GLOBAL PLAYER

GLOBAL SERVICE



- HEUFT LOCATIONS
- PARTNERS
- TIME ZONES
- HEUFT *TeleService* – online and remote diagnosis
HEUFT *PhoneService* – telephone consultation
- HEUFT *DirectService* – prompt on-site visits
- HEUFT *DeviceSupport* – live overview of the current device status





HEUFT *TeleService*

Online remote diagnosis and maintenance.



HEUFT *PhoneService*



HEUFT *DirectService*



HEUFT *DeviceSupport*

Always there for you!

24/7 on-call duty for constant availability in the event of a failure.

Real remote maintenance in real time

Stable online connection with the nearest local service technician in the HEUFT network for direct access to the device in question – identifying and solving problems promptly.

Secure tunnel

Firewall and password protected, encrypted VPN IPsec point-to-point connection to any nodes in the HEUFT network.

Up-to-date hardware and easy handling

New, compact HEUFT *GATEWAY* ¹¹ server with simplified network configuration for all HEUFT *SPECTRUM* and HEUFT *SPECTRUM* ¹¹ systems. Straightforward commissioning and easy web-based administration by your own IT team. Display for current status messages. Automatic security updates. Individual solutions with customer-specific network configuration possible.

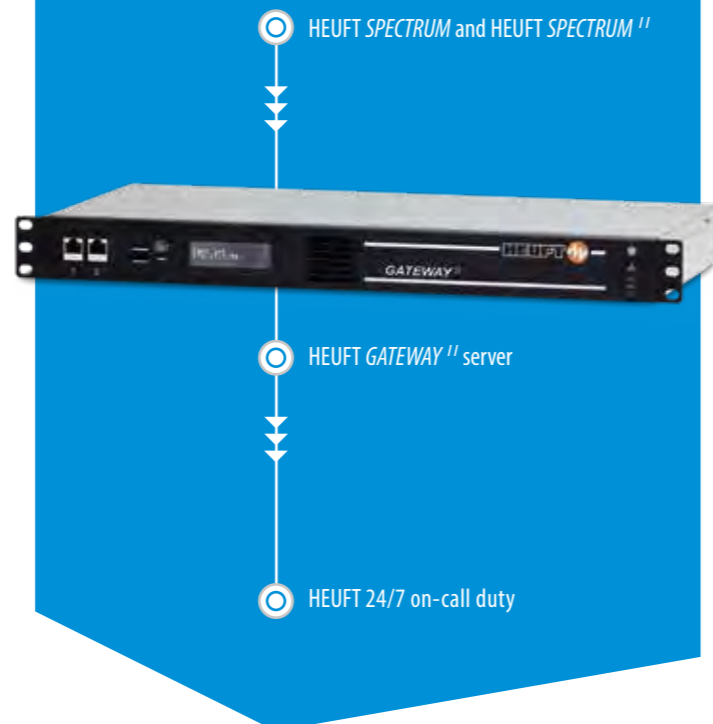

Hotline for powerful support.

The HEUFT *PhoneService* is also continuously available. You can contact qualified HEUFT technicians with field experience on the service hotline for our customers seven days a week around the clock. Unlike clueless call centre agents they know exactly what has to be done and support you comprehensively with targeted assistance at inland call rates: the respective problem is diagnosed reliably and solved directly. A prompt on-site visit is arranged immediately if in an exceptional case this should not be possible remotely.

Fast and effective on-site visits.

You need a service technician at your premises? Then you can count on the fast response times of the HEUFT *DirectService*! With 14 international locations and additional service representatives all over the world the swift arrival of competent experts is always ensured. They deal skilfully with everything necessary for restoring the full availability and operational reliability of your HEUFT systems as quickly as possible.

Online customer portal for a simply better overview and rapid response.

The HEUFT *DeviceSupport* provides you with an overview of the status and the complete technical documentation for all the installed HEUFT systems including available counter readings, messages and basic documents. In addition the browser-based online portal ensures effective spare parts and service management – with an always up-to-date illustrated spare parts list, virtual shopping basket and service visit calendar. The HEUFT *DeviceSupport* provides safety, transparency and up-to-dateness with user-specific, password protected access rights, customisable desktop, the individual grouping of device lists, user-definable alternative device names and the easy downloading of the latest firmware and software.

VISIT US IN OUR CUSTOMER CENTER



SHOWROOM

Experience the complete range of HEUFT solutions in action: our arena with almost 1,000 square metres of exhibition space provides you with the perfect conditions to convince yourself of the superior performance of our inspection and quality assurance systems – even with live tests using products from your own portfolio upon request.

Visit@heuft.com | +49 2636 56 0



TRAINING

The right know-how for reliable operation: experienced experts will provide you with all the knowledge you need in order to safeguard the functionality and availability of your HEUFT system sustainably in the HEUFT Training Center – not only theoretically but also directly at the device!

Training@heuft.com | +49 2636 56 2671



SERVICE

The nerve centre for a proactive customer service: our service control centre coordinates all the services on your premises from online remote maintenance with the HEUFT *TeleService*, the HEUFT *PhoneService* up to HEUFT *DirectService* visits – for a world-wide 24/7 support.

Technical.Desk@heuft.com | +49 2636 56 278



CONFERENCES

From seminar room to auditorium for 199 guests: we are pleased to make our premises containing state-of-the-art multimedia equipment available to customers and partners for meetings and events – including a tour of the premises, specialist lectures and practical presentations!

Welcome@heuft.com | +49 2636 56 0



Technological milestones

1978 1979 1982 1988

The first **HEUFT fill level detection** and the world's first ever **multi-segment rejection** system.

The founding of **HEUFT SYSTEMTECHNIK GMBH**.

The world's first ever device for an **in-line quality inspection** with operator guidance using a **monitor**.

Market launch of the universal **HEUFT SPECTRUM** platform for modular inspection systems.

1991 1998 1999 2001 2002

HEUFT EBI – the **first empty bottle inspector** for an efficient **linear operation**.

Market launch of the first **HEUFT TORNADO** labelling machine.

HEUFT SPECTRUM TX – a network-compatible platform for modular inspection systems with the **HEUFT PILOT** graphical user interface.

HEUFT InLine – an empty container inspection on an area of only one square metre.

HEUFT squeezer – a leakage check for filled plastic containers.

In-house developed **HEUFT reflex** image processing system with specific object detection.

HEUFT PROFILER – production data acquisition and line analysis.

Technological milestones

2003

HEUFT eXaminer – unique pulsed X-ray technology for a careful and precise foreign object detection.

2005

HEUFT FinalView for an extensive final examination of the container dress.

HEUFT conveyor – container transport in accordance with the **HEUFT CleanDesign**.

2010

HEUFT reflex² real-time image processing system with specific object detection and classification.

HEUFT beetec – a direct drive for container conveyors.

2011

HEUFT PRIME full container check – the first self-explanatory device with the revolutionary audiovisual **HEUFT NaVi** user guidance.

2013

HEUFT SPECTRUM II – the latest generation of the universal device platform for a wide variety of inspection tasks with significantly increased performance and automation as well as the self-explanatory audiovisual **HEUFT NaVi** user guidance.

2014

HEUFT InLine II IXS – the first empty container inspector with pulsed X-ray technology based on the **HEUFT SPECTRUM II**.

Optimised **HEUFT eXaminer** – technology with X-ray strobes and full-field image converters based on the **HEUFT SPECTRUM II** for even more detection accuracy when detecting foreign objects.

2015

2016

HEUFT RECIPER – brand and recipe management.

HEUFT LAMBDA-K – a complete system comprising conveyor mechanics, conveyor control system and multi-segment rejector for a careful upright container rejection in a confined space.

2017

HEUFT ONE – a new device category for an affordable introduction to a full container inspection on a HEUFT level.

The latest, even more powerful release of the universal, highly automated **HEUFT SPECTRUM II** device platform.

HEUFT InLine II IS – the new standard of fully automatic optical empty bottle inspection on a HEUFT level.

2019

40 years of HEUFT
40 years of innovation
40 years of true inspection
40 years of safe beverages, food and pharmaceuticals
40 years a reliable partner at your side
40 years much more ...

GLOBAL PLAYER

● HEUFT subsidiaries ● HEUFT partners



V5_2022-1

HEUFT SYSTEMTECHNIK GMBH

Am Wind 1 · 56659 Burgbrohl · Germany · heuft.com · info@heuft.com